



RETRACTABLE
PERGOLAS

PALMIYE
Four Seasons Outdoor Living Areas

Expose Your Outdoor World
to **Happiness**

It's All About
F A S H I O N

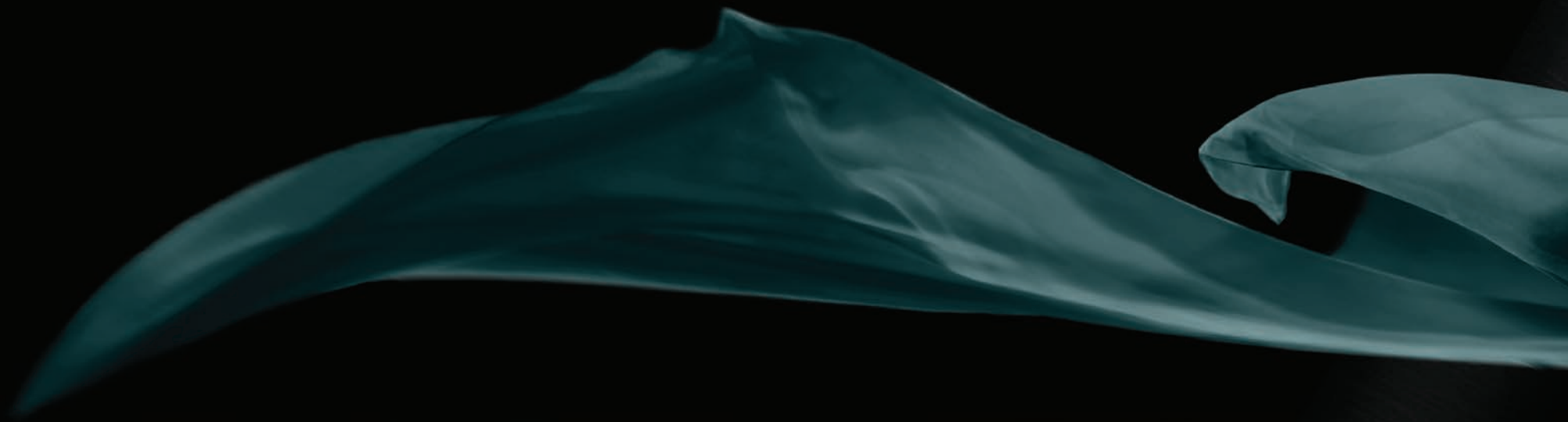



EXCLUSIVE
FABRIC COLLECTION



Feel the Exclusivity



EXCLUSIVE
FABRIC PROFILE







EXCLUSIVE
3 AXIS LIGHTING

View the World
in a Different Light

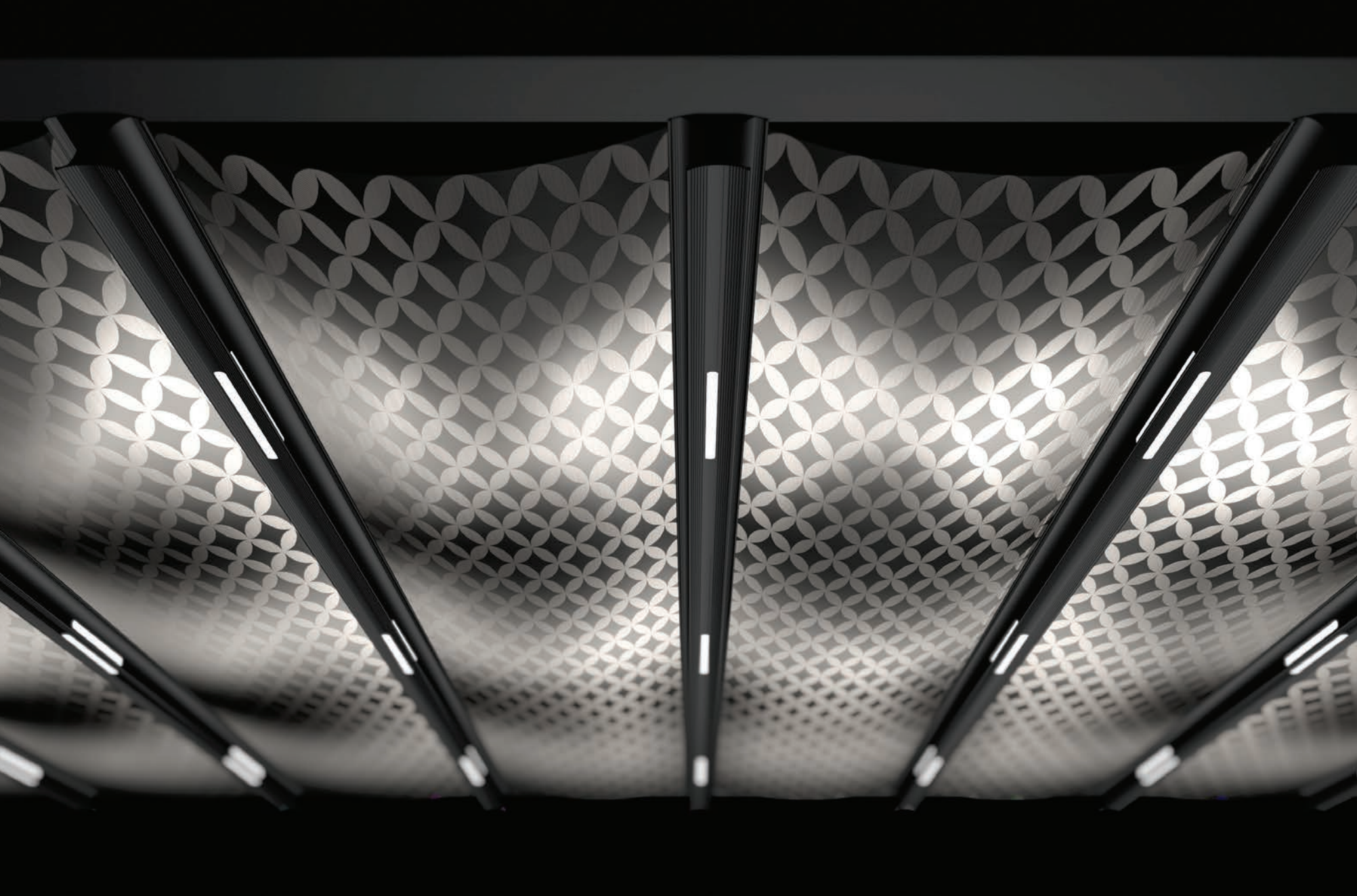

INDEX

14

MODELS

16
SILVER

22
CORAL

28
SATIN

32
GALA

38
CROWN

48
PAVILION

54
PANORAMA

60
APOLLO

66
MARINE

72
BRIDGE

78
LEGEND

82
COSMO

86

DETAILS & OPTIONS

Lighting System

Side Cover Options

Motor & Automation

Water Drainage & Sealing

Structural Design

Application Types & Solutions

Skylight Application

A person stands on a rocky peak, their arms raised in a gesture of triumph or joy. They are silhouetted against a vibrant sunset sky, with the sun low on the horizon. Below them, a vast sea of white clouds stretches to the horizon, creating a dreamlike atmosphere. The overall scene conveys a sense of achievement and looking beyond expectations.

Beyond the Expectations

M O D E L S

SILVER



CORAL



SATIN



GALA



CROWN



PAVILION



PANORAMA



APOLLO



MARIN 



BRIDGE 



LEGEND 



COSMO 



SILVER

A modern outdoor lounge area at night. The scene features a swimming pool with blue lighting, a pergola with integrated LED lighting, and a seating area with orange armchairs and a coffee table. The background shows a dark sky and a body of water with a city skyline in the distance. The overall atmosphere is sophisticated and contemporary.



With its clean lines and modern design, Silver is an unobtrusive yet stylish way to get the best out of your outdoor area, distinguishing itself from other establishments in the neighbourhood.

SILVER
PLUS

PALMINE

MAXIMUM DIMENSIONS

Width	1300
Projection	1000
Max Rail Centers	450

Silver Plus is a retractable roof system, adapted to aluminium structure. With its clean and modern design, Silver Plus adds value to your outdoor areas.

The product is usable according to its User Manual in all-weather conditions and designed to be used in all four seasons. If desired the product can be made into retractable winter garden by closing the sides with different kinds of enclosures.

Palmiye presents a wide range of ceiling covers, with a selection of colours, materials, (such as PVC, fabric) and patterns which are imported from Europe and U.S, with 5 years guaranty against fading and mould.

The entire drainage system is integrated into the structure and lighting systems can be adapted to the ceiling cover which moves together with it.

The Spot Lights or Linear Lights are installed on the aluminium profiles and can be controlled by a remote control or with a remote controlled dimmer function.

Each of our products is hand crafted and in itself unique, and from ceiling cover to construction material, you can completely customize your products.

Palmiye is proud to present its own MyPalmiye App which has been designed specifically for Palmiye products and is available at Apple's App Store.

PROFILE SECTIONS

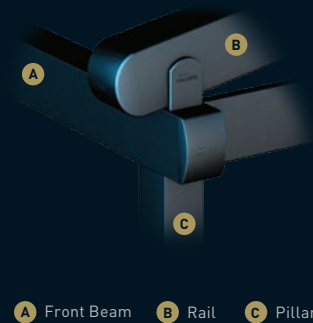

Rail Type I
12x15



Rail Type II
12x15



Front Beam
10X15



Gutter
13X13



Pillar
10X10

Projection up to 8m

SILVER

COMPACT

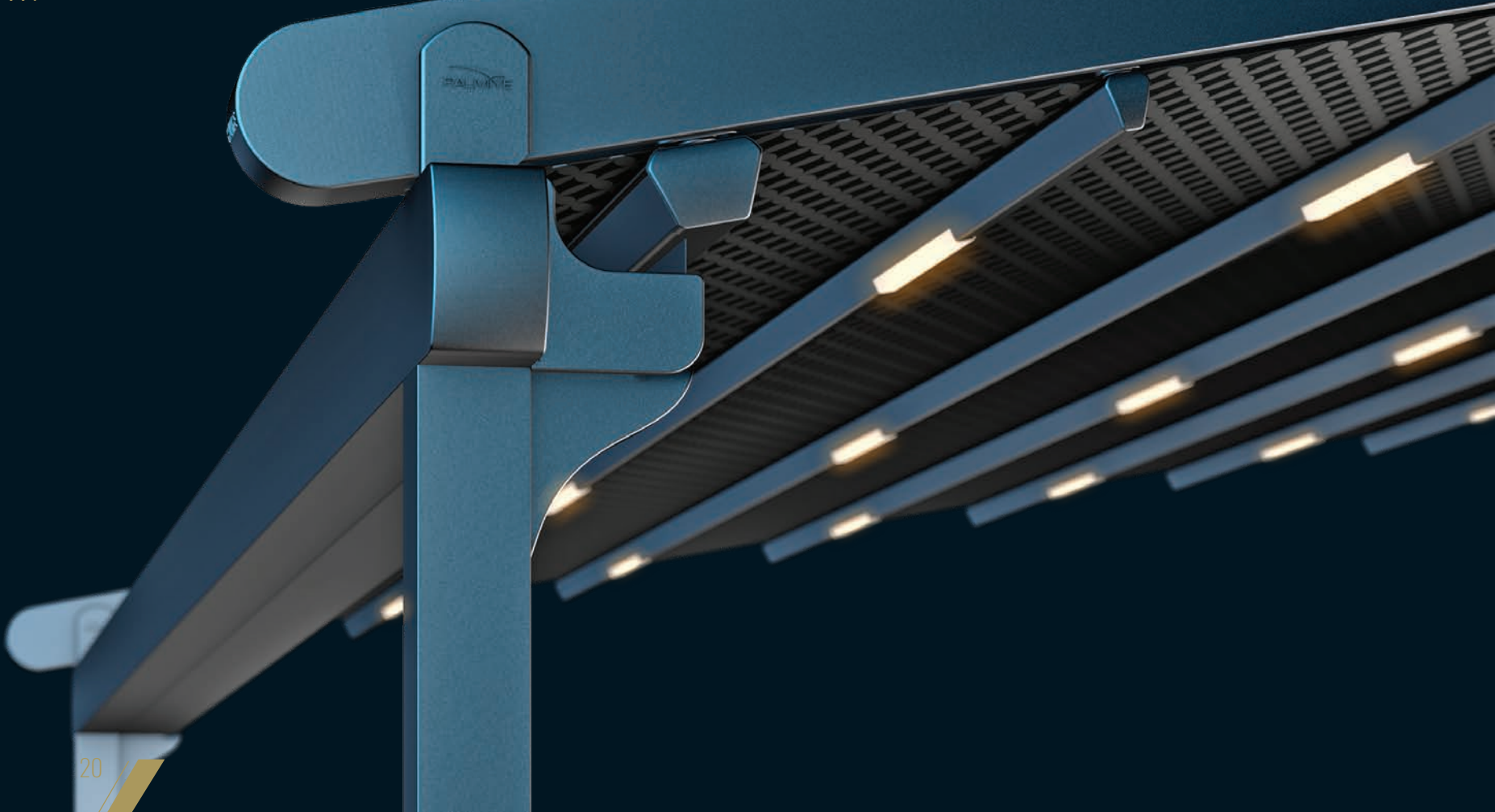

MAXIMUM DIMENSIONS

Width	1300
Projection	600
Max Rail Centers	450

Silver Compact is a compact retractable roof system, adapted to an aluminium structure. Contemporary and stylish, Silver Compact is an attractive addition to your outdoor area.

Palmiye presents a wide range of ceiling covers, with a selection of colours, materials and patterns which are imported from Europe and U.S, with 5 years guaranty against fading and mould.

The entire drainage system is integrated into the structure and lighting systems can be adapted to the ceiling cover which moves together with it.

The Spot Lights or Linear Lights are installed on the aluminium profiles and can be controlled by a remote control or with a remote controlled dimmer function.

Each of our products is hand crafted and in itself unique and from ceiling cover to construction material, you can completely customize your products.

Palmiye is proud to present its own MyPalmiye App which has been designed specifically for Palmiye products and is available at Apple's App Store.

PROFILE SECTIONS

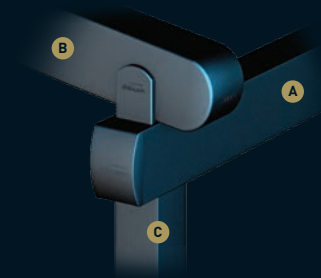

A Front Beam **B** Rail **C** Pillar



Rail
7.5X12



Front Beam
8X13



Gutter
13X13



Pillar
8X8

CORNAL





Embracing your home and your family, Coral is a beautiful addition to your abode.

The perpendicular roof and soft contours provide a welcome retreat from which you can watch the world go by!

CORAL
PLUS



MAXIMUM DIMENSIONS

Width	1300
Projection	800
Max Rail Centers	400

Coral Plus is a beautiful addition to your abode. The perpendicular roof and soft contours provide a welcome retreat from which you can watch the world go by.

The product is usable according to its User Manual in all-weather conditions and designed to be used in all four seasons. If desired the product can be made into retractable winter garden by closing the sides with different kinds of enclosures.

Palmiye presents a wide range of ceiling covers, with a selection of colours, materials (such as PVC, fabric) patterns which are imported from Europe and U.S, with 5 years guaranty against fading and mould.

The entire drainage system is integrated into the structure and lighting systems can be adapted to the ceiling cover which moves together with it.

The Spot Lights or Linear Lights are installed on the aluminium profiles and can be controlled by a remote control or with a remote controlled dimmer function.

Each of our products is hand crafted and in itself unique, and from ceiling cover to construction material you can completely customize your products.

Palmiye is proud to present its own MyPalmiye App which has been designed specifically for Palmiye products and is available at Apple's App Store.

PROFILE SECTIONS

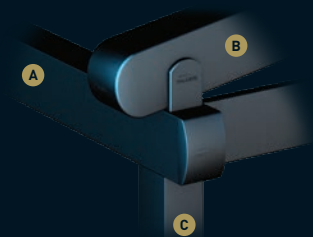

A Front Beam B Rail C Pillar



Rail
12x15

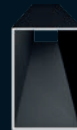

Front Beam
10x15



Gutter
13x13



Pillar
10x10

CORNAL
COMPACT

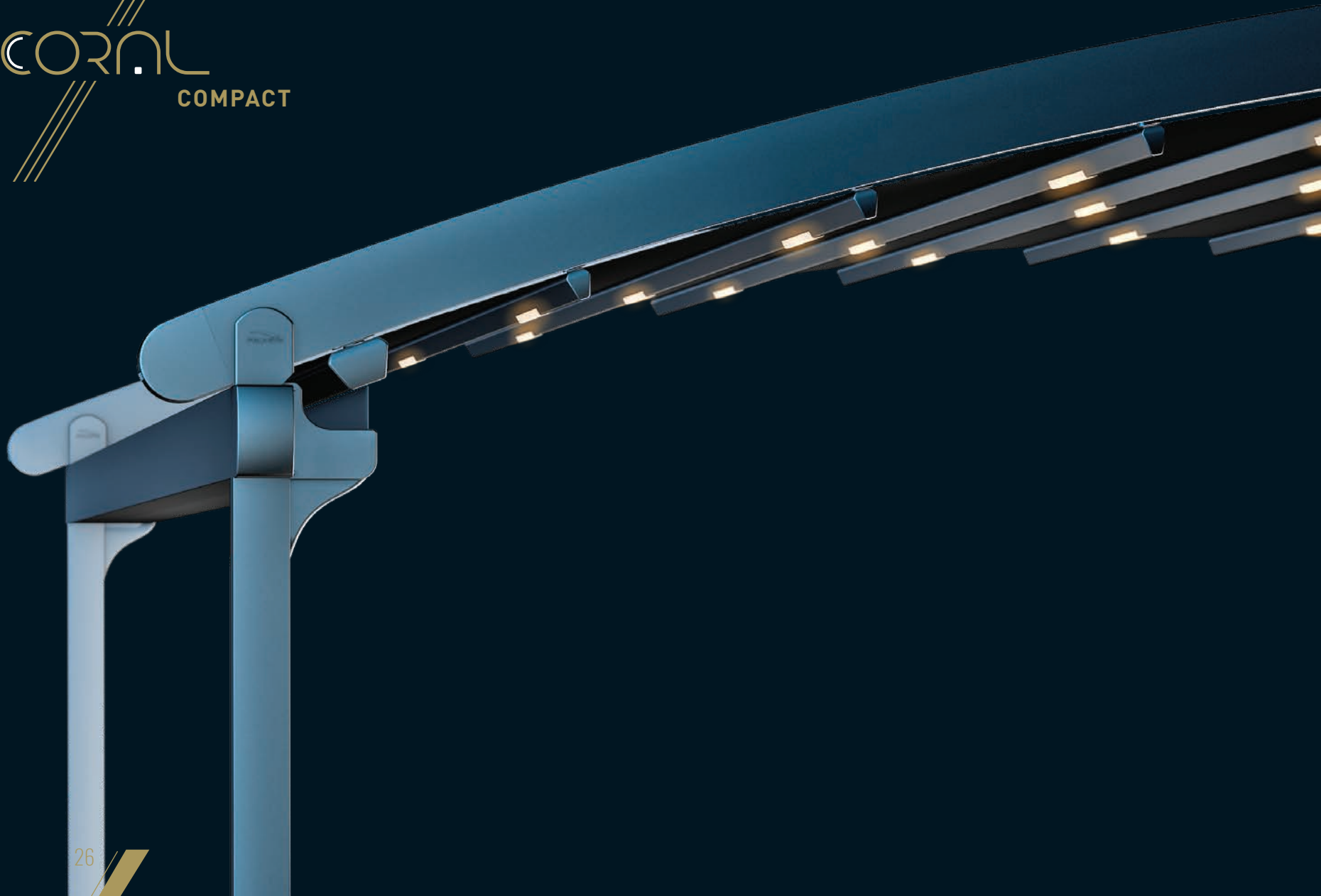

MAXIMUM DIMENSIONS

Width	1300
Projection	600
Max Rail Centers	400

Coral Compact is a soft sophisticated little addition to your home. Neat and tidy it nestles onto your outside space as if it's always been there.

Palmiye presents a wide range of ceiling covers, with a selection of colours, materials (such as PVC, fabric) patterns which are imported from Europe and U.S, with 5 years guaranty against fading and mould.

The entire drainage system is integrated into the structure and lighting systems can be adapted to the ceiling cover which moves together with it.

The Spot Lights or Linear Lights are installed on the aluminium profiles and can be controlled by a remote control or with a remote controlled dimmer function.

Each of our products is hand crafted and in itself unique, and from ceiling cover to construction material you can completely customize your products.

Palmiye is proud to present its own MyPalmiye App which has been designed specifically for Palmiye products and is available at Apple's App Store.

PROFILE SECTIONS

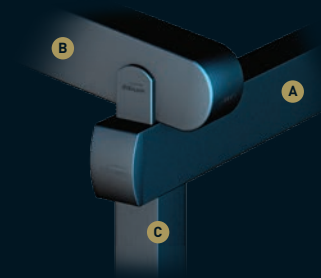

A Front Beam B Rail C Pillar

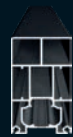

Rail Profile
7.5x12

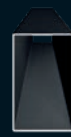

Front Beam
8x13



Gutter
13x13



Pillar
8x8

SATIN





The epitome of relaxation, with its clean lines and modern design Satin will protect, enhance and soothe at the same time.

Be at one with nature, and experience the therapy of the great outdoors, throughout the year.

SATIN

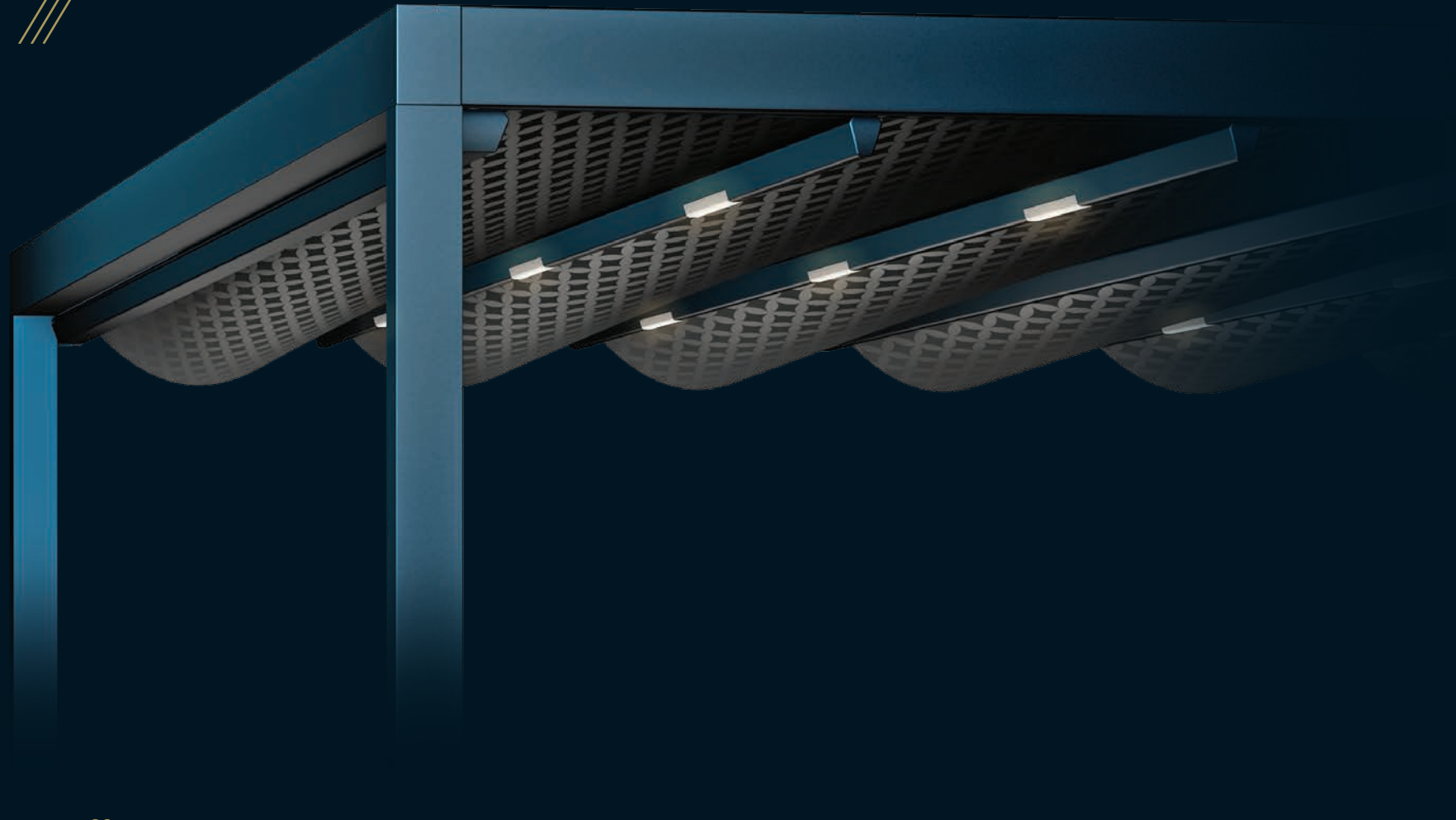

MAXIMUM DIMENSIONS

Width	900
Projection	800
Max Rail Centers	450

It is a special designed retractable roof system with its flat aluminium construction.

Palmiye presents a wide range of ceiling covers, with a selection of colours, material (such as PVC, fabric) and patterns which are imported from Europe and U.S, with 5 years guaranty against fading and mould.

Drainage system can be integrated into the structure according to the ceiling cover type (trapezium or wavy)

Lighting systems can be adapted to the ceiling cover which moves together with it. The Spot Lights or Linear Lights are installed on the aluminium profiles and can be controlled by a remote control or with a remote controlled dimmer function.

Each of our products is hand crafted and in itself unique, and from ceiling cover to the construction material you can completely customize your products.

Palmiye is proud to present its own MyPalmiye App which has been designed specifically for Palmiye products and is available at Apple's App Store.

PROFILE SECTIONS



Rail
12x15



Front Beam
10x15



Trapezium Gutter
20x55



Pillar
10x10

A Front Beam B Rail C Pillar

GALA





Specially designed to accommodate large numbers, this stylish construction provides the perfect setting to entertain your guests.

Spacious and stylish, Gala is the ultimate outdoor experience.

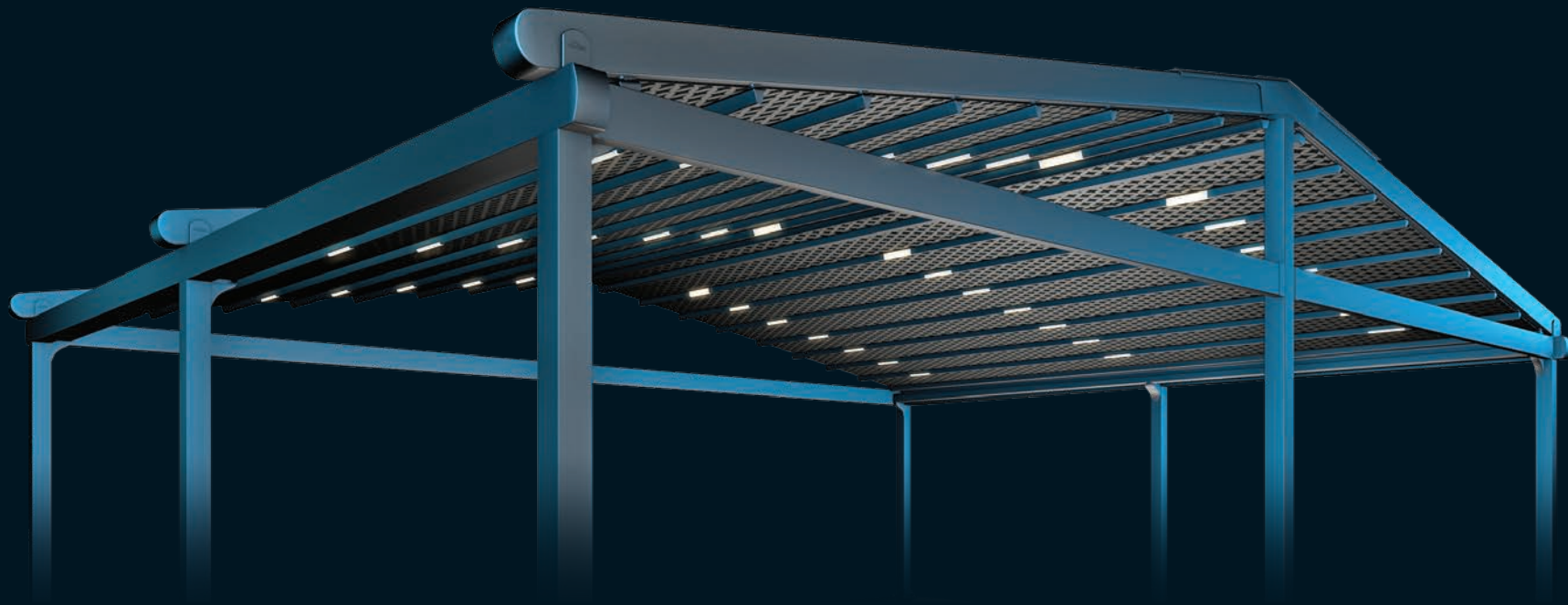

MAXIMUM DIMENSIONS

Width	1300
Projection	2000
Max Rail Centers	450

Specially designed to accommodate large numbers, this stylish construction provides the perfect setting to entertain your guests. Spacious and stylish Gala Plus is the ultimate outdoor experience.

The product is usable according to its User Manual in all-weather conditions and designed to be used in all four seasons. If desired the product can be made into a retractable winter garden by closing the sides with different kinds of enclosures.

Palmiye presents a wide range of ceiling covers, with a selection of colours, materials and patterns which are imported from Europe and U.S, with 5 years warranty against fading and mould.

The entire drainage system is integrated into the structure and lighting systems can be adapted to the ceiling cover which moves together with it. The Spot Lights or Linear Lights are installed on the aluminium profiles and can be controlled by a remote control or with a remote controlled dimmer function.

Each of our products is hand crafted and in itself unique, and from ceiling cover to the construction material you can completely customize your products.

Palmiye is proud to present its own MyPalmiye App which has been designed specifically for Palmiye products and is available at Apple's App Store.

PROFILE SECTIONS

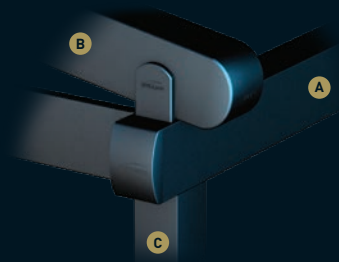

A Front Beam B Rail C Pillar



Rail Type 1
12x15



Rail Type 2
12x15



Front Beam
10x15



Gutter
13x13



Pillar
10x10

Projection up to 16m

GALA
COMPACT

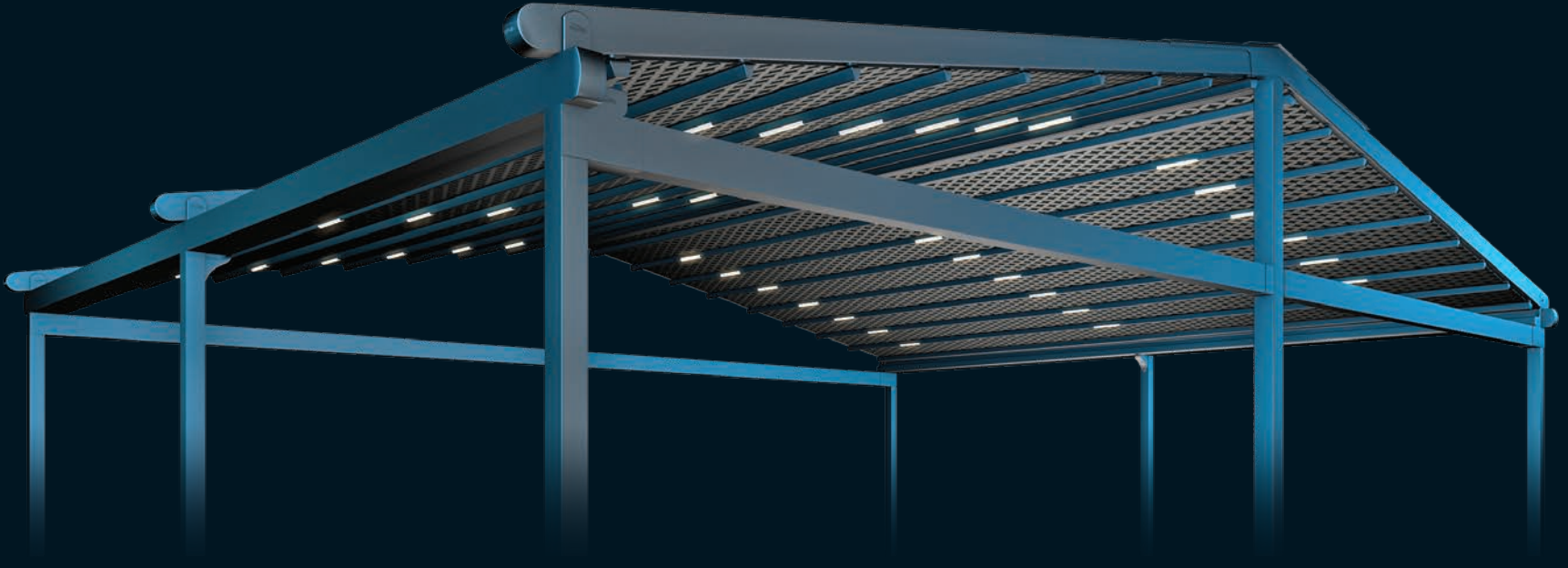

MAXIMUM DIMENSIONS

Width	1300
Projection	1200
Max Rail Centers	450

The streamline construction of Gala Compact is the ultimate party space! With its slender yet robust architecture you and your guests can literally 'raise the roof'!

Palmiye presents a wide range of ceiling covers, with a selection of colours, materials and patterns which are imported from Europe and U.S, with 5 years guaranty against fading and mould.

The entire drainage system is integrated into the structure and lighting systems can be adapted to the ceiling cover which moves together with it.

The Spot Lights or Linear Lights are installed on the aluminium profiles and can be controlled by a remote control or with a remote controlled dimmer function.

Each of our products is hand crafted and in itself unique, and from ceiling cover to the construction material you can completely customize your products.

Palmiye is proud to present its own MyPalmiye App which has been designed specifically for Palmiye products and is available at Apple's App Store.

PROFILE SECTIONS



Rail
7,5x12



Front Beam
8x13



Gutter
13X13



Pillar
8x8

A Front Beam **B** Rail **C** Pillar

CROWN





This spacious design creates a relaxing atmosphere in which guests can enjoy their time to the max.

The soft contours of the design provide an intimate setting and ensure unforgettable memories.



CROWN

PLUS
Single Motor

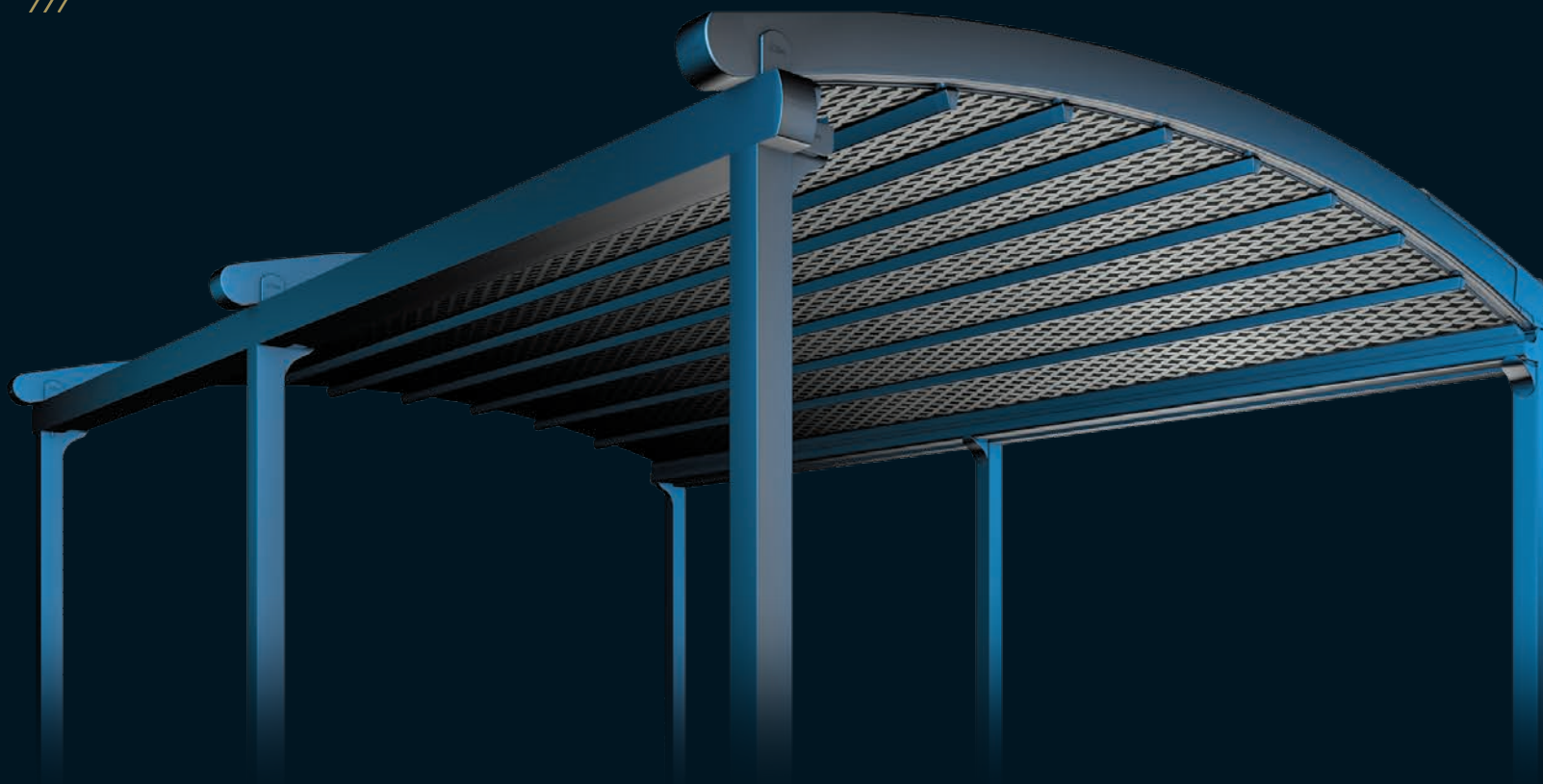

MAXIMUM DIMENSIONS

Width	1300
Projection	800
Max Rail Centers	350

* Max projection may change according to the width.

This spacious design creates a relaxing atmosphere in which guests can enjoy their time to max. The soft contours of the design provide an intimate setting and ensure unforgettable memories. In this product the ceiling cover is retracting as one piece.

The product is usable according to its User Manual in all-weather conditions and designed to be used in all four seasons. If desired the product can be made into retractable winter garden by closing the sides with different kinds of enclosures.

Palmiye presents a wide range of ceiling covers, with a selection of colours, materials and patterns which are imported from Europe and U.S, with 5 years guaranty against fading and mould.

The entire drainage system is integrated into the structure and lighting systems can be adapted to the ceiling cover which moves together with it.

The Spot Lights or Linear Lights are installed on the aluminium profiles and can be controlled by a remote control or with a remote controlled dimmer function.

Each of our products is hand crafted and in itself unique, and from ceiling cover to the construction material you can completely customize your products.

PROFILE SECTIONS

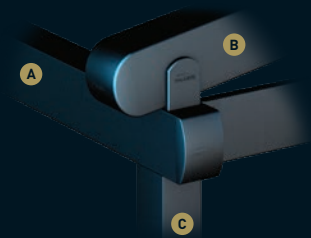

A Front Beam **B** Rail **C** Pillar



Rail
12x15



Front Beam
10X15



Gutter
13X13



Pillar
10X10

CROWN

PLUS
Double Motor

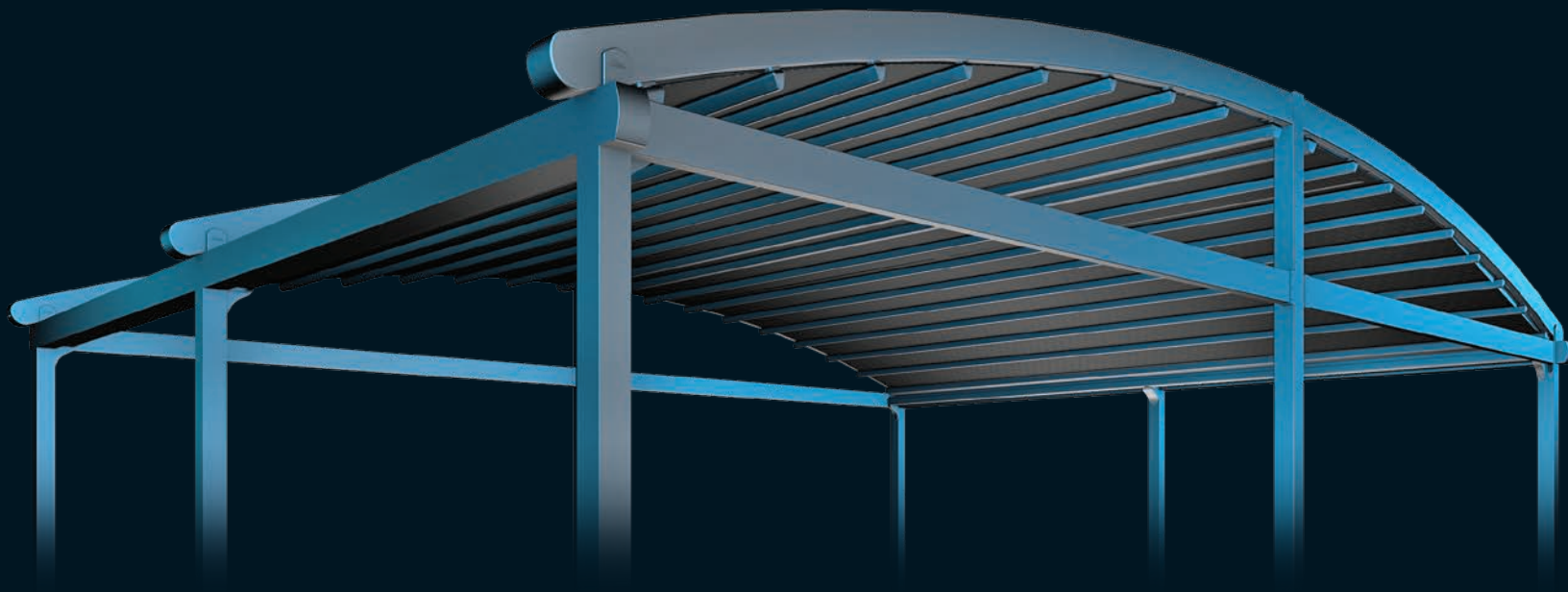

MAXIMUM DIMENSIONS

Width	1300
Projection	1600
Max Rail Centers	400

This spacious design creates a relaxing atmosphere in which guests can enjoy their time to max. The soft contours of the design provide an intimate setting and ensure unforgettable memories. In this product the ceiling cover is retracting as two pieces.

The product is usable according to its User Manual in all-weather conditions and designed to be used in all four seasons. If desired the product can be made into retractable winter garden by closing the sides with different kinds of enclosures.

Palmiye presents a wide range of ceiling covers, with a selection of colours, materials and patterns which are imported from Europe and U.S, with 5 years guaranty against fading and mould.

The entire drainage system is integrated into the structure and lighting systems can be adapted to the ceiling cover which moves together with it.

The Spot Lights or Linear Lights are installed on the aluminium profiles and can be controlled by a remote control or with a remote controlled dimmer function.

Each of our products is hand crafted and in itself unique, and from ceiling cover to the construction material you can completely customize your products.

PROFILE SECTIONS

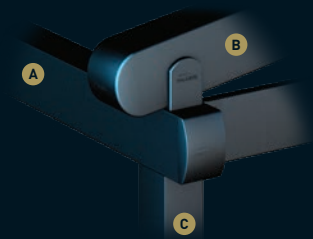

A Front Beam B Rail C Pillar



Rail
12x15



Front Beam
10X15



Gutter
13X13



Pillar
10X10

CROWN

COMPACT
Single Motor

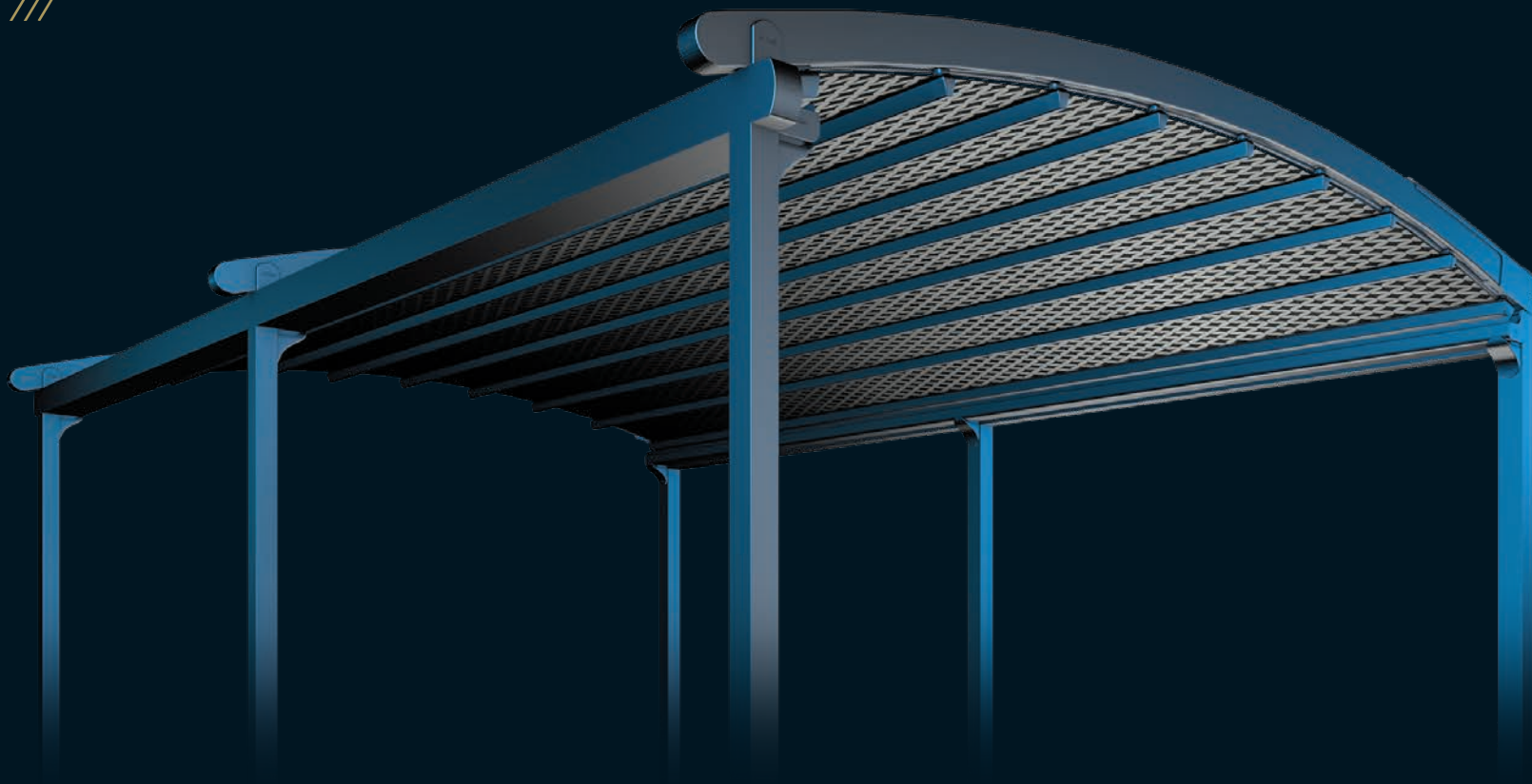

MAXIMUM DIMENSIONS

Width	1300
Projection	600
Max Rail Centers	350

* Max projection may change according to the width.

The intimate design of Crown Compact provides a welcoming area in which guests can retreat. The curvaceous architecture contributes to the cosiest of setting in all outdoor spaces. In this product the ceiling cover is retracting as one piece.

Palmiye presents a wide range of ceiling covers, with a selection of colours, materials and patterns which are imported from Europe and U.S, with 5 years guaranty against fading and mould.

The entire drainage system is integrated into the structure and lighting systems can be adapted to the ceiling cover which moves together with it.

The Spot Lights or Linear Lights are installed on the aluminium profiles and can be controlled by a remote control or with a remote controlled dimmer function.

Each of our products is hand crafted and in itself unique, and from ceiling cover to the construction material you can completely customize your products.

Palmiye is proud to present its own MyPalmiye App which has been designed specifically for Palmiye products and is available at Apple's App Store.

PROFILE SECTIONS

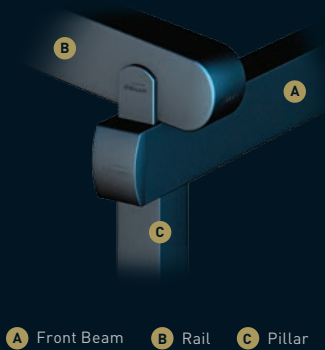

Rail
7,5x12



Front Beam
8x13



Gutter
13x13



Pillar
8x8

A Front Beam **B** Rail **C** Pillar

CROWN

COMPACT
Double Motor

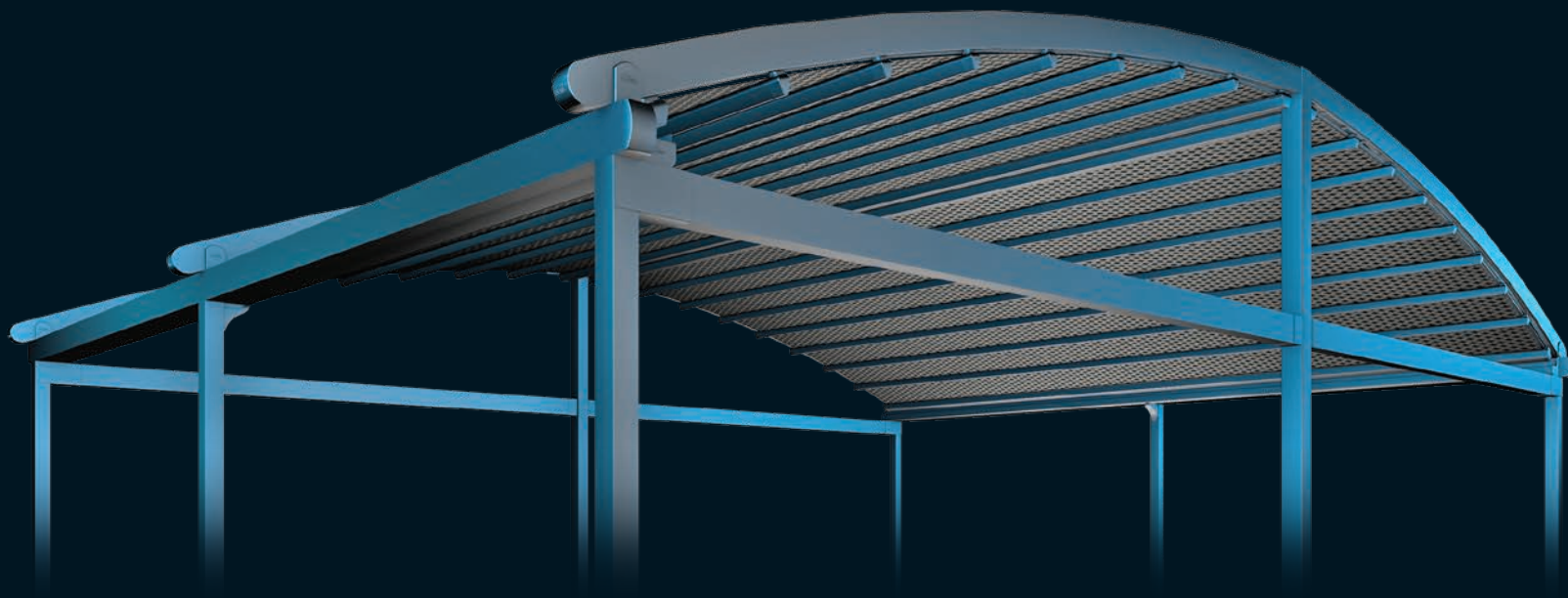

MAXIMUM DIMENSIONS

Width	1300
Projection	1200
Max Rail Centers	400

The intimate design of Crown Compact provides a welcoming area in which guests can retreat. The curvaceous architecture contributes to the cosiest of setting in all outdoor spaces. In this product the ceiling cover is retracting as two pieces.

Palmiye presents a wide range of ceiling covers, with a selection of colours, materials and patterns which are imported from Europe and U.S, with 5 years guaranty against fading and mould.

The entire drainage system is integrated into the structure and lighting systems can be adapted to the ceiling cover which moves together with it.

The Spot Lights or Linear Lights are installed on the aluminium profiles and can be controlled by a remote control or with a remote controlled dimmer function.

Each of our products is hand crafted and in itself unique, and from ceiling cover to the construction material you can completely customize your products.

Palmiye is proud to present its own MyPalmiye App which has been designed specifically for Palmiye products and is available at Apple's App Store.

PROFILE SECTIONS

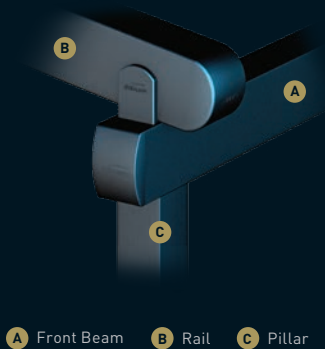

Rail
7.5x12



Front Beam
8x13



Gutter
13x13



Pillar
8x8

A Front Beam B Rail C Pillar

PAVILION





Delightfully male in appearance, this chiselled design provides ultimate garden luxury.

With its angular details and strong features, Pavilion is perfect for getting the most out of your outdoor living area throughout the year.

PAVILION



It's a stylish aluminium retractable roof system. With its angular details and strong features Pavilion has various ceiling versions as tilted, flat, double tilted, curved. Perfect for getting the most out of your outdoor living area throughout the year.

The product is usable according to its User Manual in all-weather conditions and designed to be used in all four seasons. If desired the product can be made into retractable winter garden by closing the sides with different kinds of enclosures.

Palmiye presents a wide range of ceiling covers, with a selection of colours, materials and patterns which are imported from Europe and U.S, with 5 years guaranty against fading and mould.

The entire drainage system is integrated into the structure and lighting systems can be adapted to the ceiling cover which moves together with it.

The Spot Lights or Linear Lights are installed on the aluminium profiles and can be controlled by a remote control or with a remote controlled dimmer function.

Each of our products is hand crafted and in itself unique, and from ceiling cover to the construction material you can completely customize your products.

Palmiye is proud to present its own MyPalmiye App which has been designed specifically for Palmiye products and is available at Apple's App Store.

PROFILE SECTIONS

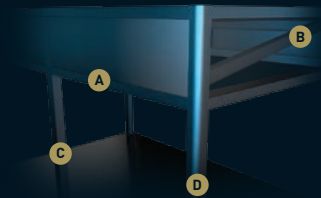

Rail Type 1
12x15



Rail Type 2
12x15



Front Beam
10x15



Gutter
13x13



Middle Pillar
12x15



Corner Pillar
15x15

A Front Beam B Rail C Middle Pillar D Corner Pillar

PAVILION



MAXIMUM DIMENSIONS Width / Projection

TILTED

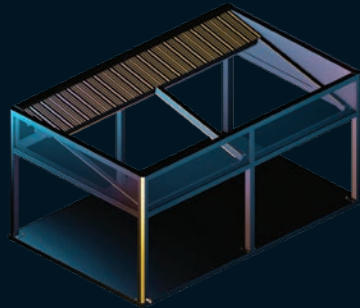

Width	1300
Projection	800
Max Rail Centers	450

FLAT

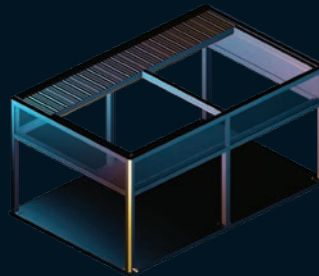

Width	1300
Projection	800
Max Rail Centers	450

DOUBLE TILTED

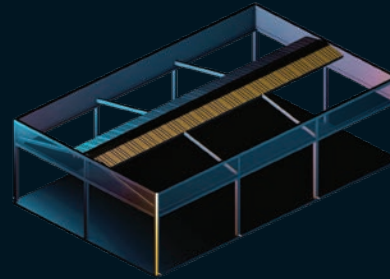

Width	1300
Projection	600
Max Rail Centers	450

CURVED

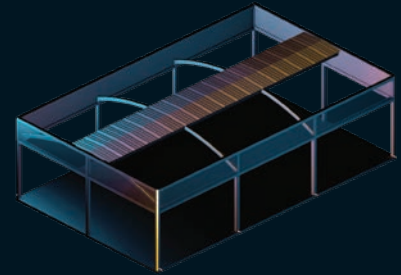

Width	1300
Projection	600
Max Rail Centers	400

PANORAMA





Panorama is remarkable in that it has no front support at all, thus allowing you to enjoy unbroken views.

Straight in design, Panorama is an unobtrusive way to enjoy the world in which you live.

PANORAMA

PLUS

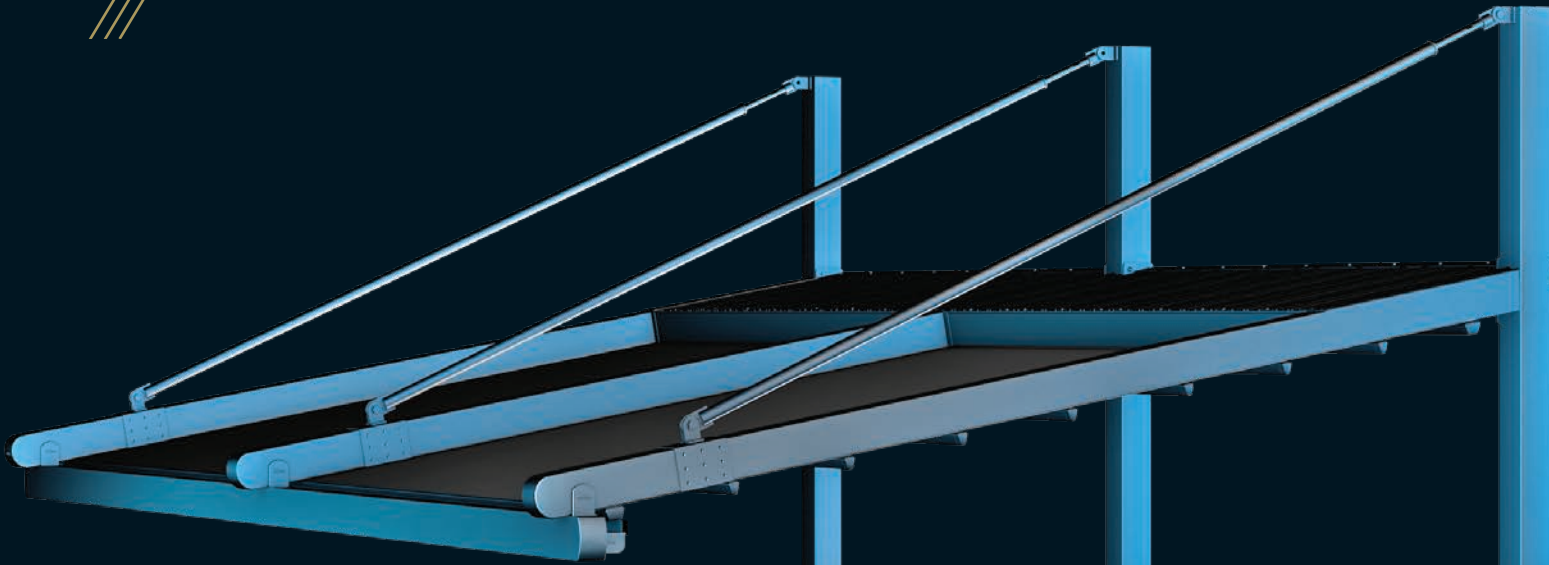

MAXIMUM DIMENSIONS

HANGING TYPE

Width	1300
Projection	600
Max Rail Centers	450

BUTRESS TYPE

Width	450
Projection	400
Max Rail Centers	450

Panorama is remarkable is that it has no front support at all, thus allowing you to enjoy unbroken views. With its modern design and the buttruss, Panorama will provide you an elegant and stylish atmosphere. Product can also be delivered with buttruss version.

The product is usable according to its User Manual in all-weather conditions and designed to be used in all four seasons.

Palmiye presents a wide range of ceiling covers, with a selection of colours, materials and patterns which are imported from Europe and U.S, with 5 years guaranty against fading and mould.

Lighting systems can be adapted to the ceiling cover which moves together with it.

The Spot Lights or Linear Lights are installed on the aluminium profiles and can be controlled by a remote control or with a remote controlled dimmer function.

Each of our products is hand crafted and in itself unique, and from ceiling cover to the construction material you can completely customize your products.

Palmiye is proud to present its own MyPalmiye App which has been designed specifically for Palmiye products and is available at Apple's App Store.

PROFILE SECTIONS

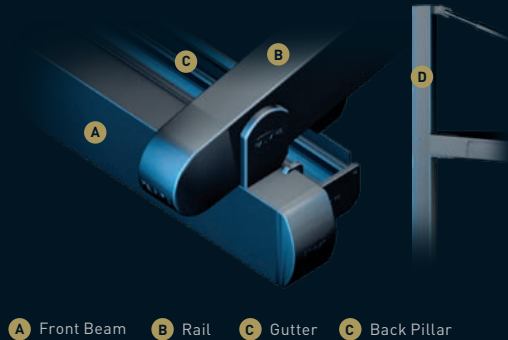

Rail
12x15



Front Beam
10X15



Gutter
13X13

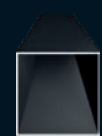

Back Pillar
15X15

- A** Front Beam **B** Rail **C** Gutter **D** Back Pillar

PANORAMA

COMPACT

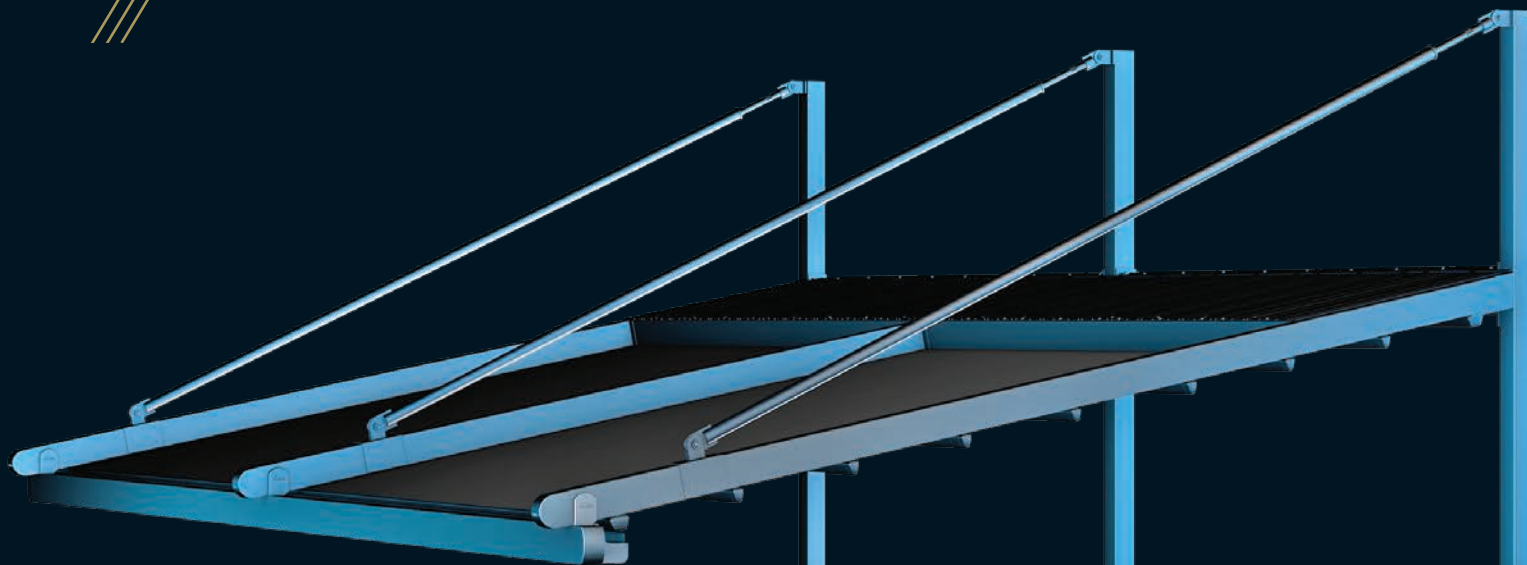

MAXIMUM DIMENSIONS

HANGING TYPE

Width	1300
Projection	600
Max Rail Centers	450

BUTRESS TYPE

Width	450
Projection	400
Max Rail Centers	450

Panorama Compact is so minimalistic, it is sometimes easy to forget its very existence! Inconspicuous and unassuming its gentle protection is a delight in every way!

Palmiye presents a wide range of ceiling covers, with a selection of colours, materials and patterns which are imported from Europe and U.S, with 5 years guaranty against fading and mould.

Lighting systems can be adapted to the ceiling cover which moves together with it.

The Spot Lights or Linear Lights are installed on the aluminium profiles and can be controlled by a remote control or with a remote controlled dimmer function.

Each of our products is hand crafted and in itself unique, and from ceiling cover to the construction material you can completely customize your products.

Palmiye is proud to present its own MyPalmiye App which has been designed specifically for Palmiye products and is available at Apple's App Store.

PROFILE SECTIONS

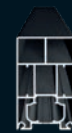
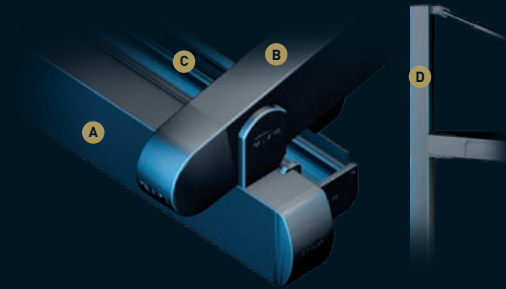

Rail
7,5X12



Front Beam
8X13



Gutter
13X13



Back Pillar
15x15

A Front Beam **B** Rail **C** Gutter **D** Back Pillar

APOLLO



Apollo is remarkable in that it has no front support at all, thus allowing you to enjoy unbroken views.

Gently arched in design, Apollo is an unobtrusive way to enjoy the world in which you live.

APOLLO

PLUS

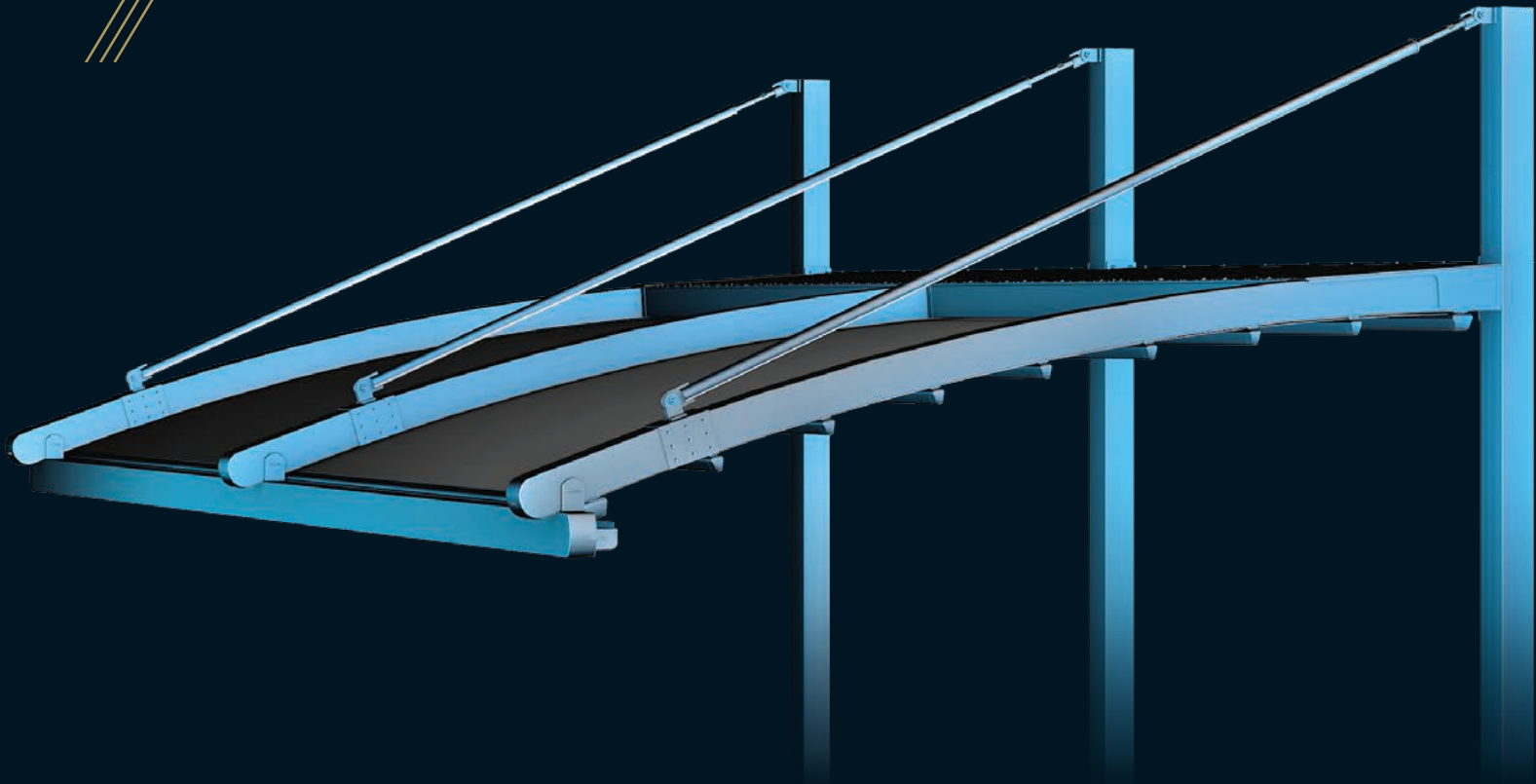

MAXIMUM DIMENSIONS

HANGING TYPE

Width	1300
Projection	600
Max Rail Centers	400

BUTRESS TYPE

Width	400
Projection	400
Max Rail Centers	400

Majestic yet graceful Apollo silently looks down, unobtrusively watching those who gather beneath it. Perfect for those who want to enjoy magnificent views in an unbroken yet protected manner! Product can be delivered with suspended or butress versions.

Palmiye presents a wide range of ceiling covers, with a selection of colours, materials and patterns which are imported from Europe and U.S, with 5 years guaranty against fading and mould.

Lighting systems can be adapted to the ceiling cover which moves together with it.

The Spot Lights or Linear Lights are installed on the aluminium profiles and can be controlled by a remote control or with a remote controlled dimmer function.

Each of our products is hand crafted and in itself unique, and from ceiling cover to the construction material you can completely customize your products.

Palmiye is proud to present its own MyPalmiye App which has been designed specifically for Palmiye products and is available at Apple's App Store.

PROFILE SECTIONS

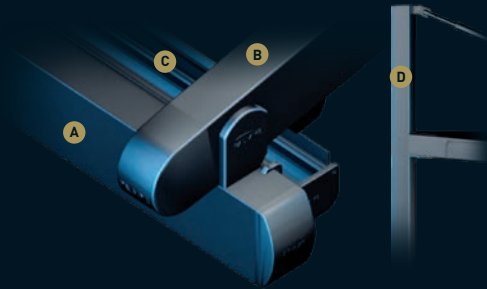

Rail
12x15



Front Beam
10x15



Gutter
13X13



Back Pillar
15x15

A Front Beam B Rail C Gutter C Back Pillar

APOLLO

COMPACT

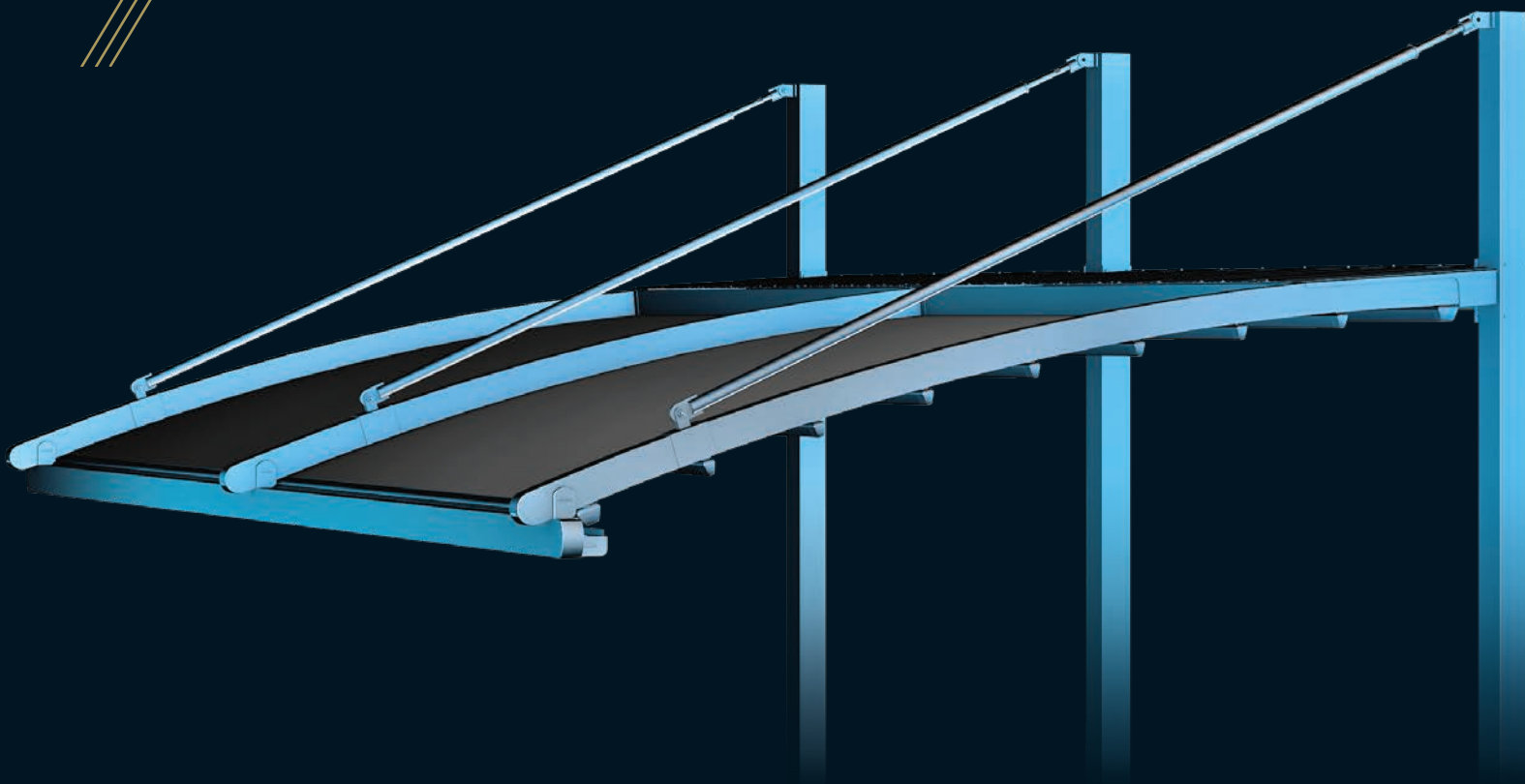

MAXIMUM DIMENSIONS

HANGING TYPE

Width	1300
Projection	600
Max Rail Centers	400

BUTRESS TYPE

Width	400
Projection	400
Max Rail Centers	400

As light as the wing of a bird. Apollo Compact exists above you, with its slender arches quietly protecting from the elements.

Palmiye presents a wide range of ceiling covers, with a selection of colours, materials and patterns which are imported from Europe and U.S, with 5 years guaranty against fading and mould.

Lighting systems can be adapted to the ceiling cover which moves together with it. The Spot Lights or Linear

Lights are installed on the aluminium profiles and can be controlled by a remote control or with a remote controlled dimmer function.

Each of our products is hand crafted and in itself unique, and from ceiling cover to the construction material you can completely customize your products.

Palmiye is proud to present its own MyPalmiye App which has been designed specifically for Palmiye products and is available at Apple's App Store.

PROFILE SECTIONS

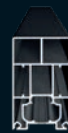
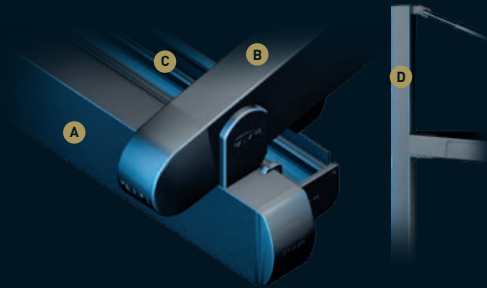

Rail
7,5x12



Front Beam
8x13



Gutter
13X13



Back Pillar
15x15

A Front Beam **B** Rail **C** Gutter **D** Back Pillar

MARIN 





This elegant product is free standing and is a stylish way to enlarge your outdoor living space.

The eye-catching nautical design creates a welcoming atmosphere and ensures that you make the best out of your area.

MARIN 
PLUS

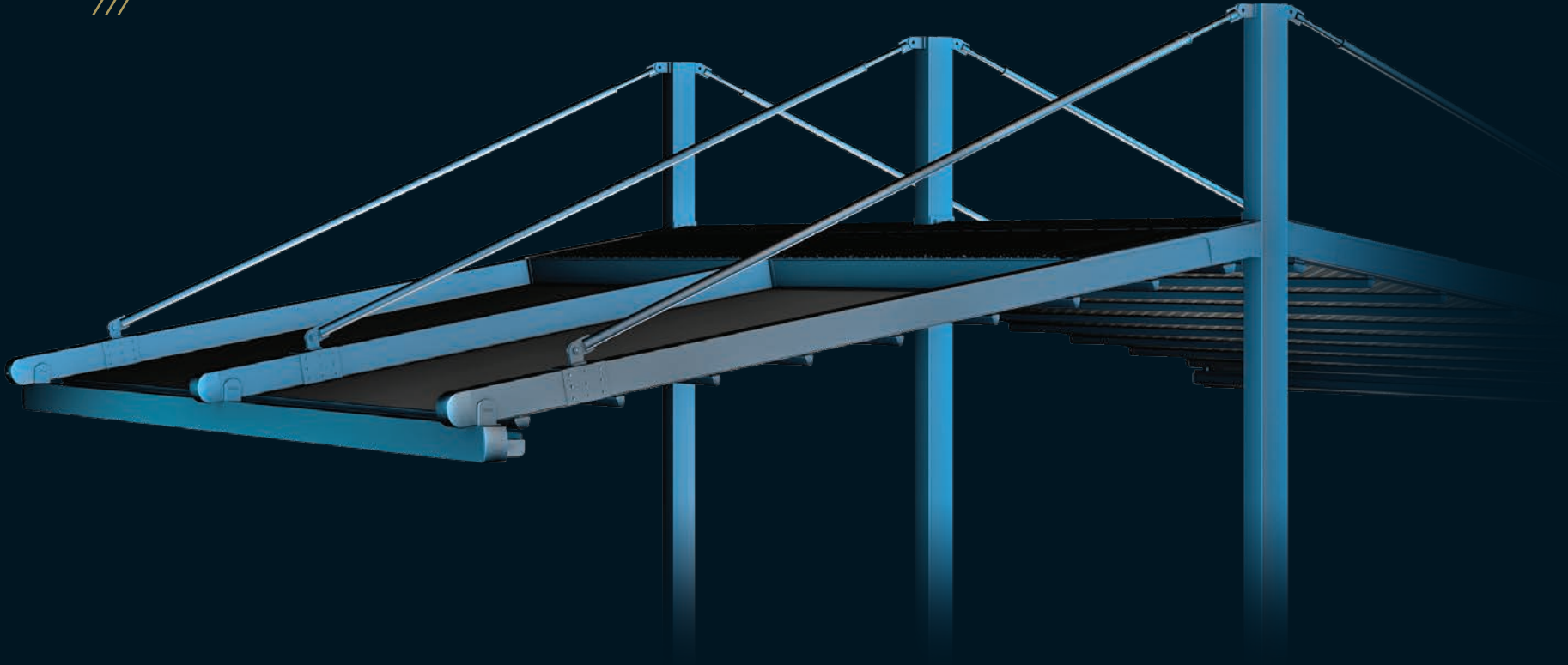

MAXIMUM DIMENSIONS

Width	1300
Projection	1200
Max Rail Centers	450

This elegant product is free standing and is a stylish way to enlarge your outdoor living space. The eye catching nautical design creates a welcoming atmosphere and ensures that you make the best out of your area. The product is usable in all-weather conditions and designed to be used in all four seasons.

Palmiye presents a wide range of ceiling covers, with a selection of colours, materials and patterns which are imported from Europe and U.S, with 5 years guaranty against fading and mould.

Lighting systems can be adapted to the ceiling cover which moves together with it.

The Spot Lights or Linear Lights are installed on the aluminium profiles and can be controlled by a remote control or with a remote controlled dimmer function.

Each of our products is hand crafted and in itself unique, and from ceiling cover to the construction material you can completely customize your products.

Palmiye is proud to present its own MyPalmiye App which has been designed specifically for Palmiye products and is available at Apple's App Store.

PROFILE SECTIONS

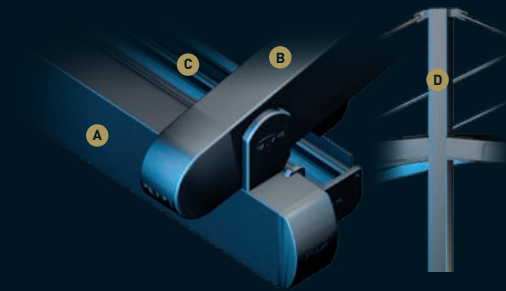

Rail
12x15



Front Beam
10x15



Gutter
13X13



Middle Pillar
15x15

A Front Beam **B** Rail **C** Gutter **D** Middle Pillar

MARIN 

COMPACT

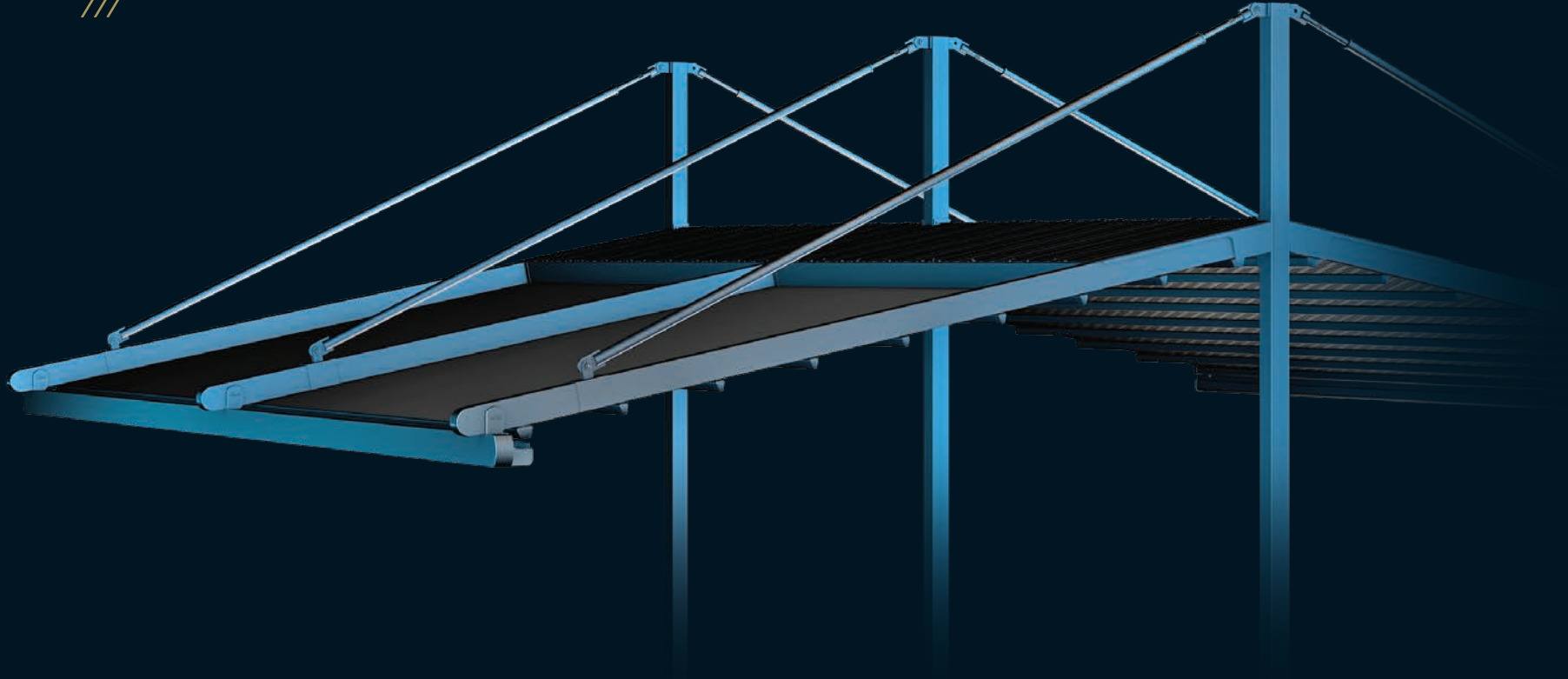

MAXIMUM DIMENSIONS

Width	1300
Projection	1200
Max Rail Centers	450

Marine Compact is a tastefully practical product. With minimalistic, lightweight details it can be moved easily around to provide you with exactly what you need.

Palmiye presents a wide range of ceiling covers, with a selection of colours, materials and patterns which are imported from Europe and U.S, with 5 years guaranty against fading and mould.

Lighting systems can be adapted to the ceiling cover which moves together with it.

The Spot Lights or Linear Lights are installed on the aluminium profiles and can be controlled by a remote control or with a remote controlled dimmer function.

Each of our products is hand crafted and in itself unique, and from ceiling cover to the construction material you can completely customize your products.

PROFILE SECTIONS

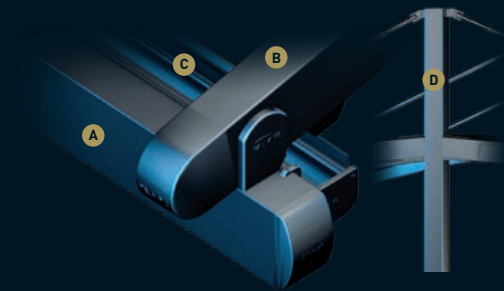

Rail
7,5x12

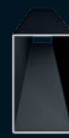

Front Beam
8x13



Gutter
13X13



Middle Pillar
15x15

A Front Beam B Rail C Gutter C Middle Pillar

BRIDGE





An architectural beauty, this free-standing product sets you apart from other establishments, attracting attention and enabling your customers to get the most from their outdoor experience.

BRIDGE
PLUS

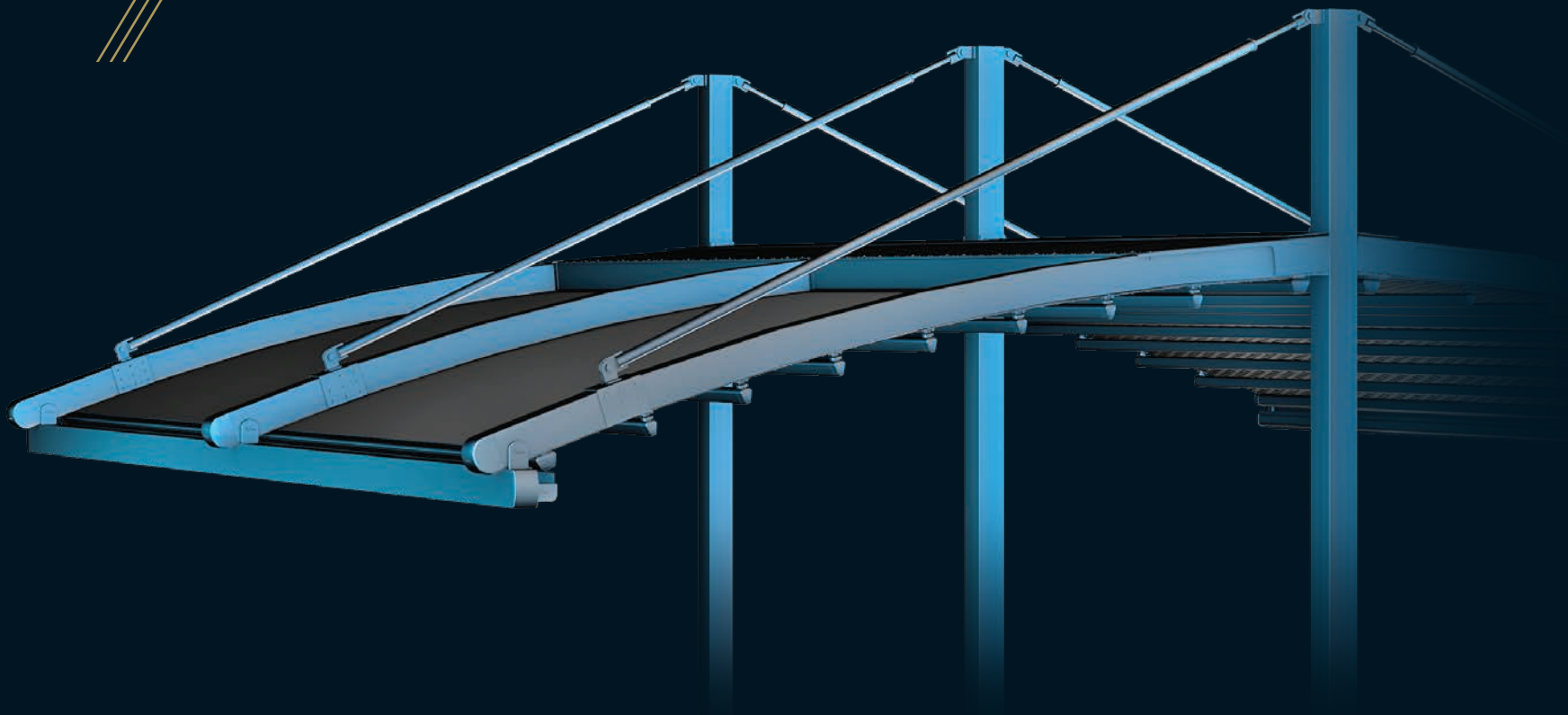

MAXIMUM DIMENSIONS

Width	1300
Projection	1200
Max Rail Centers	400

An architectural beauty this free standing product sets you apart from other establishments, attracting attention and enabling your customers to get the most from their outdoor experience.

The product is usable according to its User Manual in all-weather conditions and designed to be used in all four seasons.

Palmiye presents a wide range of ceiling covers, with a selection of colours, materials and patterns which are imported from Europe and U.S, with 5 years guaranty against fading and mould.

Lighting systems can be adapted to the ceiling cover which moves together with it.

The Spot Lights or Linear Lights are installed on the aluminium profiles and can be controlled by a remote control or with a remote controlled dimmer function.

Each of our products is hand crafted and in itself unique, and from ceiling cover to the construction material you can completely customize your products.

Palmiye is proud to present its own MyPalmiye App which has been designed specifically for Palmiye products and is available at Apple's App Store.

PROFILE SECTIONS

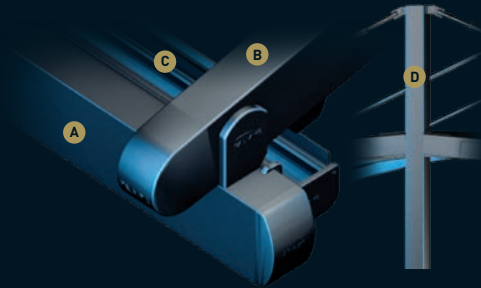

Rail
12x15



Front Beam
10x15



Gutter
13X13



Middle Pillar
15x15

A Front Beam **B** Rail **C** Gutter **D** Middle Pillar

BRIDGE

COMPACT

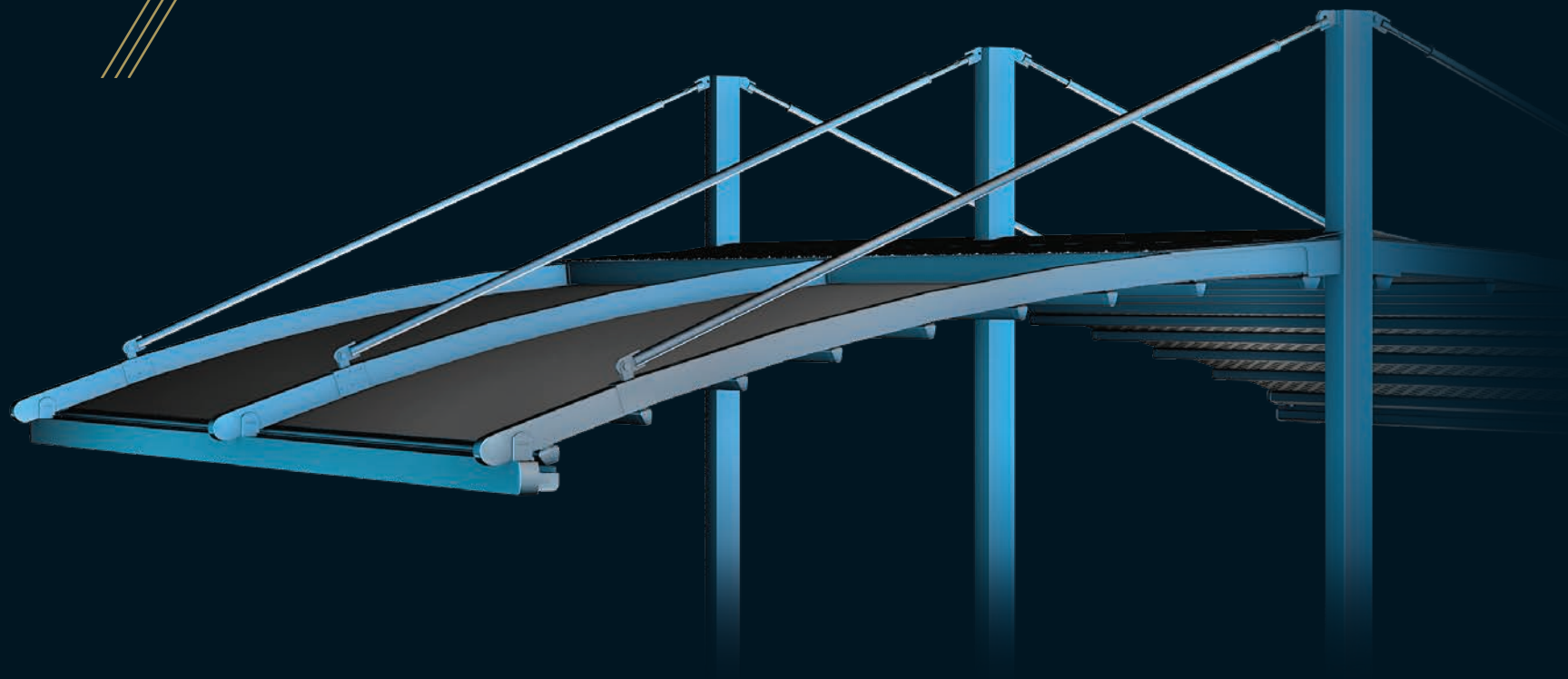

MAXIMUM DIMENSIONS

Width	1300
Projection	1200
Max Rail Centers	400

Bridge Compact is an extraordinary piece of architecture! Slim line and slender the charismatic design is sure to attract the attention of all who see it!

Palmiye presents a wide range of ceiling covers, with a selection of colours, materials and patterns which are imported from Europe and U.S, with 5 years guaranty against fading and mould.

Lighting systems can be adapted to the ceiling cover which moves together with it.

The Spot Lights or Linear Lights are installed on the aluminium profiles and can be controlled by a remote control or with a remote controlled dimmer function.

Each of our products is hand crafted and in itself unique, and from ceiling cover to the construction material you can completely customize your products.

Palmiye is proud to present its own MyPalmiye App which has been designed specifically for Palmiye products and is available at Apple's App Store.

PROFILE SECTIONS

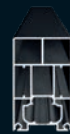
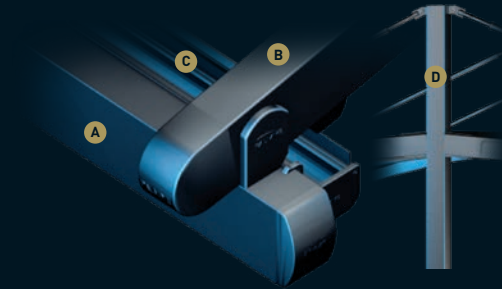

Rail
7,5X12



Front Beam
8x13



Gutter
13X13



Middle Pillar
15x15

A Front Beam B Rail C Gutter D Middle Pillar



LEGEND



Legend enables you to enjoy the pleasant warmth and light the sun provides, when and how much you want.

Ensure uninterrupted interior climate control throughout the seasons and allow the elegant finish and clean lines to add aesthetically to your interior.



LEGEND

MAXIMUM DIMENSIONS

Width	1300
Projection	1000
Max Rail Centers	450

Legend is an indispensable product, if there is an existing construction, this enables you to enjoy the pleasant warmth and light the sun provides, when and how much you want.

Palmiye presents a wide range of ceiling covers, with a selection of colours, materials and patterns which are imported from Europe and U.S, with 5 years guaranty against fading and mould.

Lighting systems can be adapted to the ceiling cover which moves together with it.

The Spot Lights or Linear Lights are being installed on the aluminium profiles and can be controlled by a remote control or with a remote controlled dimmer function.

Each of our products is hand crafted and in itself unique, and from ceiling cover to the construction material you can completely customize your products.

Palmiye is proud to present its own MyPalmiye App which has been designed specifically for Palmiye products and is available at Apple's App Store.

PROFILE SECTION



Rail Profile
5,5X9



COSMO



This attractive product with its elegant finish and clean lines allows uninterrupted interior climate control throughout the seasons.

With Cosmo you can experience the warm sunshine of spring, or the golden light of autumn exactly the way you want it!

COSMO



MAXIMUM DIMENSIONS

Width	1300
Projection	800
Max Rail Centers	400

Cosmo is an indispensable product, if there is an existing curved construction, which allows uninterrupted interior climate control throughout the seasons.

Palmiye presents a wide range of ceiling covers, with a selection of colours, material (such as PVC, fabric) and patterns which are imported from Europe and U.S, with 5 years guaranty against fading and mould.

Lighting systems can be adapted to the ceiling cover which moves together with it.

The Spot Lights or Linear Lights are being installed on the aluminium profiles and can be controlled by a remote control or with a remote controlled dimmer function.

Each of our products is hand crafted and in itself unique, and from ceiling cover to the construction material you can completely customize your products.

PROFILE SECTION



Rail Profile
5,5X9



A large, thin-lined ampersand graphic is positioned on the left side of the page. The text 'DETAILS' and 'OPTIONS' is centered within the right-hand curve of the ampersand. The text is in a bold, uppercase, sans-serif font. To the right of the text, there are two sets of three parallel diagonal lines, one set above 'DETAILS' and one set below 'OPTIONS', which appear to be part of the ampersand's design.

DETAILS
OPTIONS



LIGHTING
SYSTEM

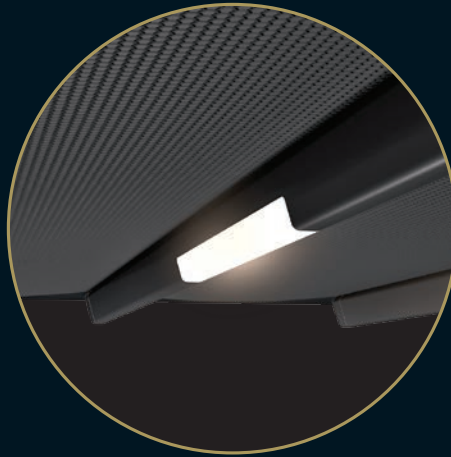

LINEAR LIGHT

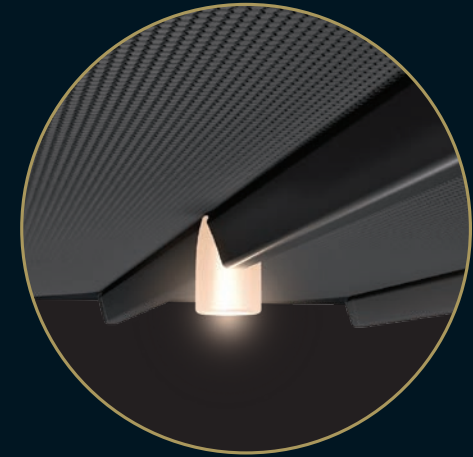

SPOT LIGHT

DIMMABLE LED LIGHT

Depending on whether you want strong practical lighting, or an atmospheric dimmed ambience, you can choose between the Spot Lights with Palmiye's 3-Lens LED Technology or the Linear Lights.

You can dim the lights directly from your Remote Control or Smart Phones. Investing in LED technologies is part of Palmiye's contribution to a greener environment.

SIDE COVER OPTIONS

For environmental protection or create outdoor living areas used throughout four seasons, Pergola sides can be covered by glass systems, louvers, drop arm awnings, external vertical zip blind, external vertical blind.





Glass Systems



Louvers

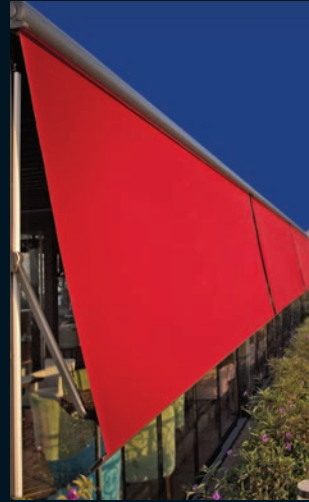

Drop Arm Awning



External Vertical Zip Blind

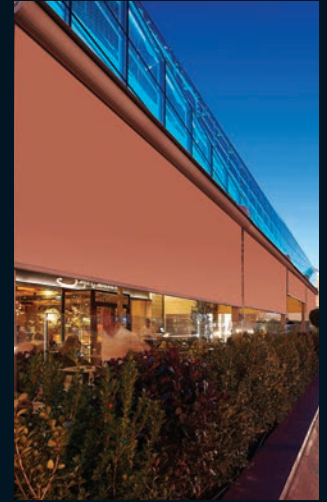

External Vertical Blind

MOTOR & AUTOMATION

A person is lying in a white mesh hammock strung between two palm trees on a tropical beach. The person is holding a smartphone. The background features clear turquoise water, a white sandy beach, and lush green hills under a bright blue sky. The hammock has a white pillow and a wooden spreader bar. The scene is peaceful and idyllic.



REMOTE CONTROL

Internationally renowned Somfy motors from France are used to operate all of our products.

Guaranteed for 5 years and using RTS technology, the motors can be operated at the simple touch of a button.



PALMIYE APPS

We are proud to present our own MyPalmiye App which has been designed specifically for Palmiye products and is available at Apple's App store. Now you can take full control of your Palmiye experience and choose from several options, directly from your iPhone or iPad.

These include:

- Activating the infra-red heaters.
- Adjusting the FourSeasons cover.
- Dimming the lights.
- Playing your favourite music.

WATER DRAINAGE & SEALING

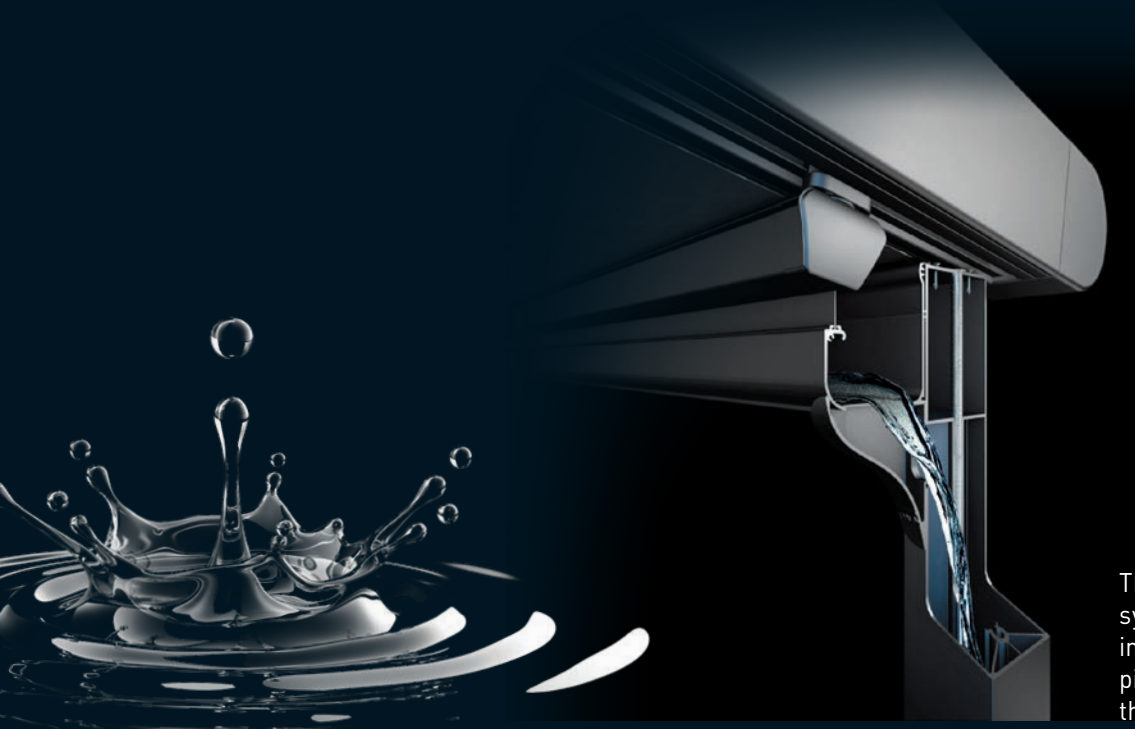

The hidden part of the drainage system which was ingeniously integrated inside both beams and pillars makes effortlessly possible the discharge of water.

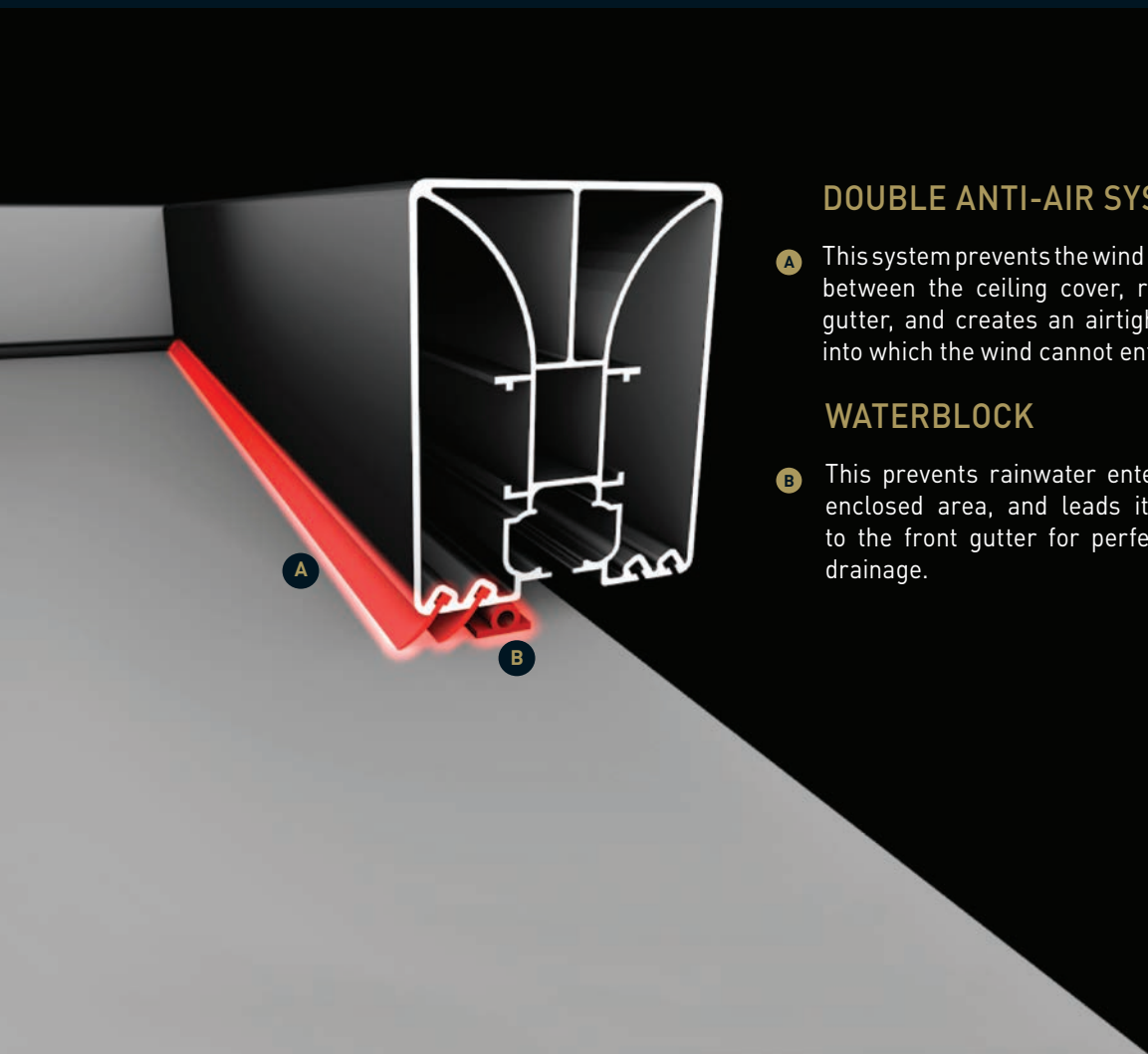

DOUBLE ANTI-AIR SYSTEM

- A This system prevents the wind entering between the ceiling cover, rails and gutter, and creates an airtight space into which the wind cannot enter.

WATERBLOCK

- B This prevents rainwater entering the enclosed area, and leads it directly to the front gutter for perfect water drainage.

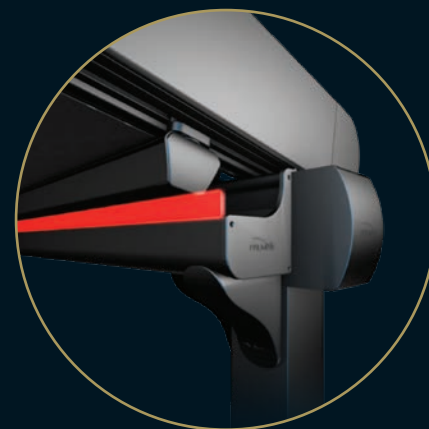

Gutter Seal

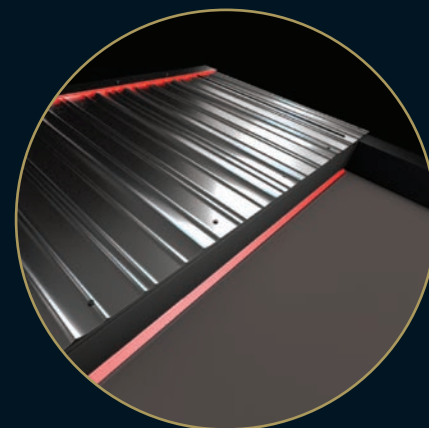

Back Seal

STRUCTURAL DESIGN

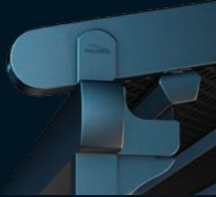

ELEGANT DESIGN

Palmiye pergolas' aesthetic appearance offers the best for those who desire elegance and perfection.

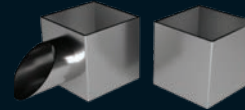

PILLAR BASE

Stainless steel base hides all the floor installations inside, drains the water to the outside and gives an exclusive finish to your product.

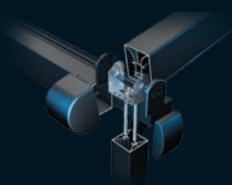

HIDDEN ASSEMBLY DETAILS

Plus and Compact series provide a clean surface and perfect view by concealing all connection details made with stainless steel screws and parts.

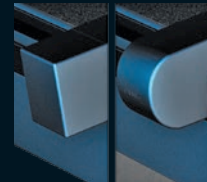

PROFILE CAP CHOICES

Give a personal touch to your pergola by choosing from a rounded or straight ended cap.



GEOMETRIC CROSS SECTION

With its geometric design, the specially engineered inner section gives maximum strength and wind resistance to the aluminium rail profile.



HORIZONTAL BEAMS

The front and side beam on the same horizontal level, giving a continuous line throughout the product, ensuring a smooth relaxing overall look, which is a delight to the eye.

* Doesn't include the compact series.

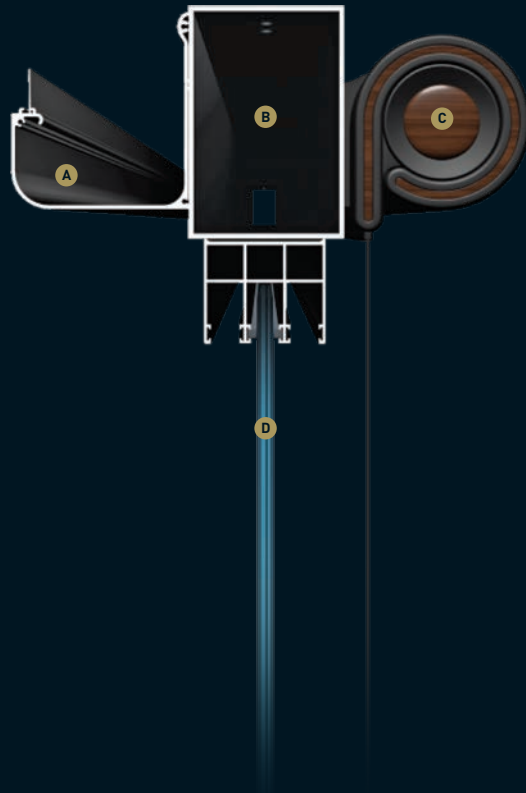

SEPARATE GUTTER PROFILE

RAIN GUTTER **A**

The gutter with its height adjustment feature, provides the anti-air system, in different positions to ensure a perfect fit, according to the inclination of your product.

SEPARATE FRONT BEAM **B**

The separated front beam carries all the weight of the roof without putting any pressure on the gutter. Additionally it is also responsible for carrying awnings and glass systems.

VERTICAL BLIND **C**

Horizontal sun rays can be reduced with a vertical blind. It is a full cassette awning and the Ferrari Soltis fabric, provides shade without interrupting the view.

GLASS SYSTEMS **D**

Different glass systems can be installed directly onto the front beam.

APPLICATION TYPES & SOLUTIONS

RAIL POSITIONING



Standard

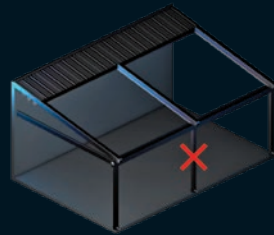

MODIFIABILITY

Allows modifications on the main constructions by changing the main aluminium beam and pillars with steel.

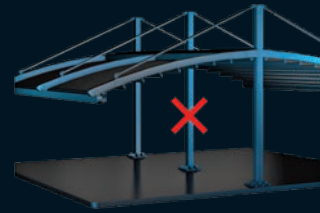

MIDDLE PILLAR REDUCTION

Provides a flexibility to remove the middle pillars by performing optional system changes.

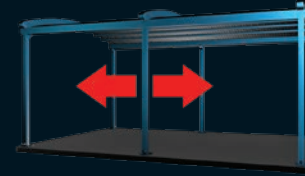

PILLAR POSITION CHANGE

Pillars have the ability to shift up to 50 cm according to the structural needs of the Project.



Custom

SKYLIGHT APPLICATION











5-YEAR WARRANTY

All our products have up to 5 years guarantee for the construction and motor. The electronics and remote controls are guaranteed for 2 years.



www.palmiye.eu



PALMIYE
Four Seasons Outdoor Living Areas